

## Wireless Smart Gate

PS-3225

Software: SPARKvue or  
PASCO Capstone

Power: Rechargeable Battery  
Connection: USB or  Bluetooth<sup>®</sup>  
SMART

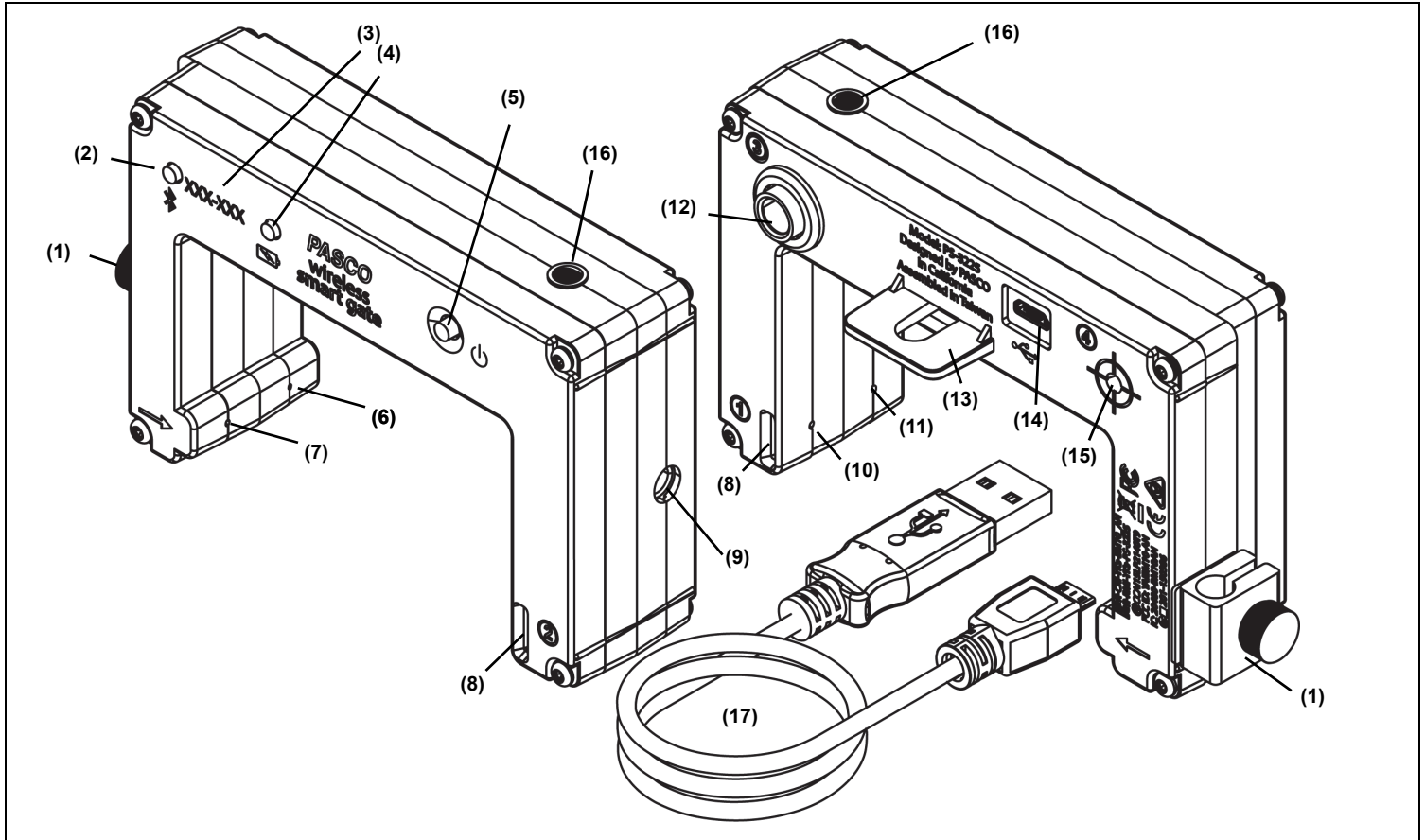

### Legend

(1) Swivel Rod Clamp <sup>1</sup>	(7) Emitter Port 2	(13) Super Pulley Tab
(2) Bluetooth LED	(8) Photogate Tape Slot	(14) USB Port
(3) Device ID	(9) 1/4-20 Threaded Hole	(15) (Port 4) Laser Detector Port
(4) Battery LED	(10) Detector Port 1	(16) Indicator LED
(5) Power Button	(11) Detector Port 2	(17) Micro USB Cable
(6) Emitter Port 1	(12) (Port 3) Auxiliary Port	

<sup>1</sup>The Swivel Rod Clamp can be detached

Required Item*	Model Number*
PASCO Data Collection Software	see <a href="http://www.pasco.com">www.pasco.com</a>

\*See the PASCO catalog or the PASCO web site [www.pasco.com](http://www.pasco.com) for more information.

## Compatible Equipment\*

Product Name	Model Number
Super Pulley	ME-9450A
Super Pulley with Mounting Rod	ME-9499
Photogate Stand	ME-9805
Picket Fence (Large)	ME-9377A
Picket Fence (Smart Timer)	ME-8933
Picket Fence (Cart)	ME-9804
Photogate Bracket (Track)	ME-9806
Photogate Mounting Bracket (Projectile Launcher)	ME-6812A
Photogate Head	ME-9498A
Accessory Photogate	ME-9204B
Time-of-Flight Accessory	ME-6810A
Photogate Tape, High Resolution	ME-6666
Photogate Pendulum Set	ME-8752

## Initial Step: Connect to a USB Port or USB Charger

Use the included Micro USB Cable to connect the Micro USB Port on the Wireless Smart Gate to a USB port or a USB charger (such as PS-2575A). When connected to a USB port or charger, the Battery LED shines yellow to show the battery is charging. When the battery is charged, the Battery LED shines green. Allow 3 hours for charging.

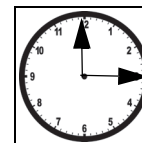

## Introduction

The PASCO Wireless Smart Gate is a versatile measuring device that can connect to a computer or mobile device wirelessly through Bluetooth (BLE) or physically with a Micro USB cable. It measures the time for an object's motion, such as a PASCO Cart, as the object blocks one or more beams of light. The Smart Gate has three detector ports and one Auxiliary port. There are slots for Ports 1 and 2 for Photogate Tape (ME-6663) or Photogate Tape, High Resolution (ME-6666).

Port 1 and Port 2 operate in the same way as a pair of PASCO Photogates that are side-by-side. The space between the emitters for Port 1 and Port 2 is 1.5 cm. PASCO Capstone or SPARKvue software records and displays the times for a variety of timing combinations such as the amount of time each port is blocked, or the time from when one port is blocked until the second port is blocked. The software also displays the values of calculations such as the speed or velocity between Port 1 and Port 2.

Port 3, the Auxiliary Port, is the port for a PASCO Photogate or similar device such as a Time-of-Flight Accessory. The Auxiliary port accepts a 0.25 inch (6.35 mm) "tip-ring-sleeve" phono plug.

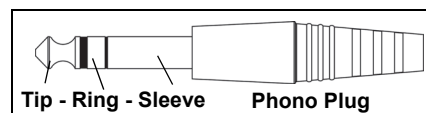

Port 4, the Laser Detector Port, is designed to work with a laser beam to allow measurement of an object too large to pass through the Wireless Smart Gate. The software begins recording time when a laser beam shining into the port is blocked by a passing object.

## Data Collection Software

### PASCO Capstone



- Mac OS X
- Windows

### SPARKvue



- Mac OS X
- Windows
- iOS
- Android
- Chromebook

Measurements from the sensor are recorded and displayed using PASCO software such as SPARKvue or PASCO Capstone. SPARKvue allows the sensor to work with a computer or a mobile device such as a tablet, datalogger, or smart-phone when the sensor is connected. PASCO Capstone will work on a PC or Mac.

See the PASCO web site at [www.pasco.com/software](http://www.pasco.com/software) for help in selecting the right PASCO software and to check for the latest versions.

### ON/OFF and Sleep Information

To turn the sensor on, press and hold the Power Button until the Battery LED shines red for a moment, and then release the Power Button. The Bluetooth LED will blink to indicate that the sensor is ready to be “paired” with a device using the PASCO software. The sensor puts itself to sleep after one hour of inactivity if connected, and after several minutes if not connected. To turn the sensor off, press and **hold** the Power Button for a moment until the Battery LED shines red. Release the Power Button and the Bluetooth LED stops blinking.

## Hardware Set-Up

### Mounting the Wireless Smart Gate to a Pulley Mounting Rod

A Pulley Mounting Rod (SA-9343) fits the 1/4-20 threaded hole that is on the side of the Wireless Smart Gate opposite to the swivel rod clamp.

The swivel rod clamp and thumbscrew allows the Wireless Smart Gate to be mounted on a 0.63 cm (1/4 in.) diameter rod (such as the ME-9805 Photogate Stand).

The open space for the Wireless Smart Gate is 7.2 cm (width) by 4.0 cm (depth). Remember, the Laser Detector Port (Port 4) allows the measurement of the motion of larger objects when used with a laser.

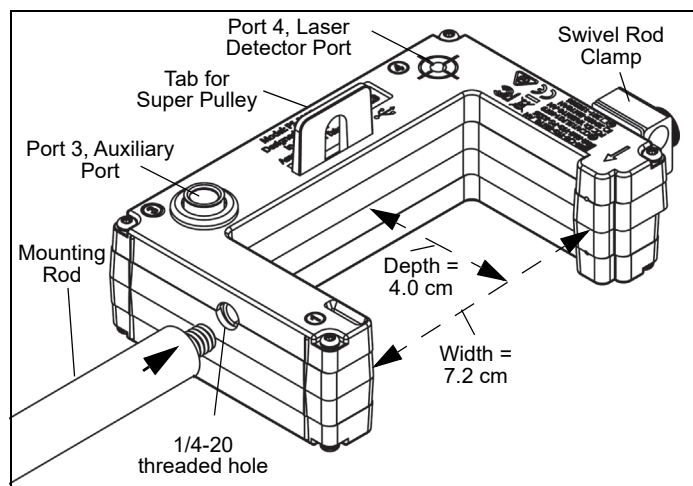

### Adding a Super Pulley to the Wireless Smart Gate

The tab on the Wireless Smart Gate housing provides a seat for attaching a PASCO Super Pulley (ME-9450A) using a Pulley Mounting Rod. When using a Super Pulley with the Wireless Smart Gate, only Detector Port 1 (“gate 1”) will record state changes caused by the rotating pulley.

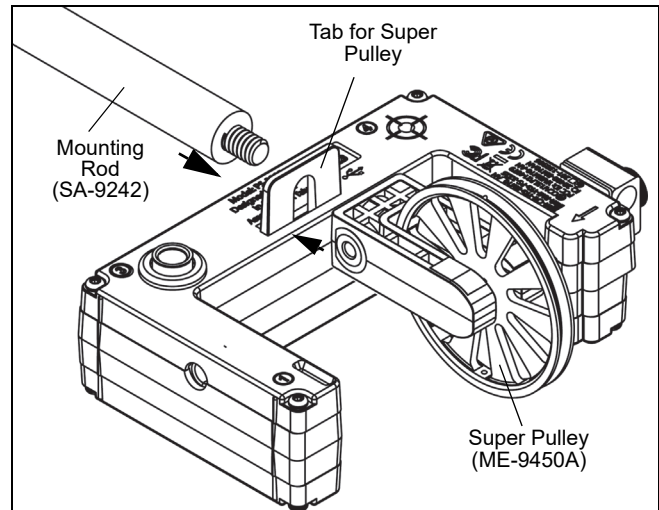

### Mounting the Wireless Smart Gate on a PASCO Track

The Wireless Smart Gate can be attached to the side of a PASCO Track with a Photogate Bracket (ME-9806). Slide the square nut on the Photogate Bracket into the T-slot of the side of the PASCO track. Remove the swivel rod clamp from the side of the Wireless Smart Gate (but save the swivel rod clamp for later use).

Use the short thumbscrew from the Photogate Bracket assembly to attach the Wireless Smart Gate to the Photogate Bracket.

Note that half of the Wireless Smart Gate housing fits between the “rails” on each edge of one side of the Photogate Bracket, and the Wireless Smart Gate can be adjusted up or down. If you wish to adjust the Photogate Bracket to an angle relative to the PASCO track, mount the bracket on the track with the smooth side of the bracket against the edge of the track. The small thumbscrew will hold the Wireless Smart Gate in place against the smooth side of the bracket. Both the Photogate Bracket and the Wireless Smart Gate can then be set at any angle.

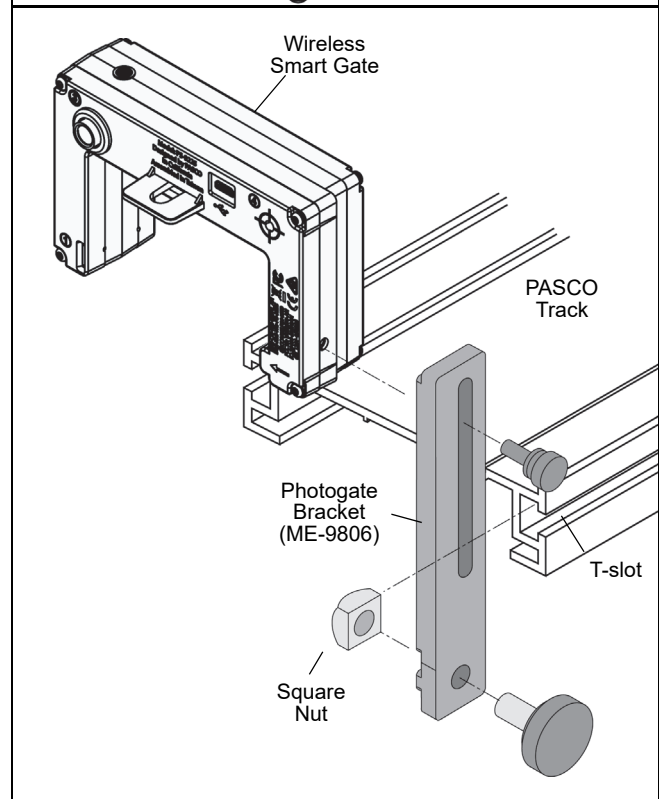

### Mounting the Wireless Smart Gate on a PASCO Projectile Launcher

Use a Photogate Mounting Bracket (ME-6821A) to attach the Wireless Smart Gate to a PASCO Projectile Launcher (see the PASCO web site for more information about launchers).

Clamp the PASCO Projectile Launcher in place. Mount the Photogate Mounting Bracket to the T-slot of the Projectile Launcher. Adjust the bracket so that the second position on the bracket is aligned with the end of the launcher. Remove the swivel rod clamp from the side of the Wireless Smart Gate (but save the swivel rod clamp for later use). Use one of the smaller thumbscrews from the Photogate Mounting Bracket (ME-6821A) to attach the Wireless Smart Gate to the Photogate Mounting Bracket as shown.

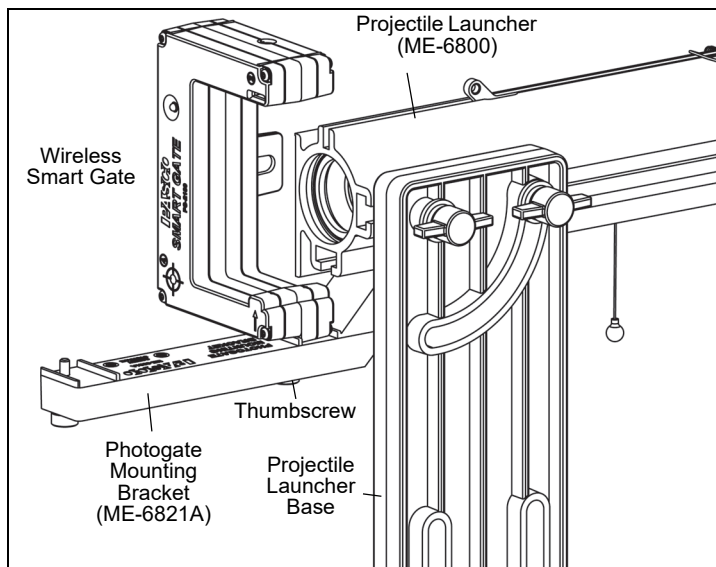

### Using the Wireless Smart Gate with the Time-of-Flight Accessory

The PASCO Time-of-Flight Accessory (ME-6810A) is designed for projectile motion experiments. The Time-of-Flight Accessory can be used with a Wireless Smart Gate mounted on a Projectile Launcher to measure the time of a projectile's motion from launch to landing. Connect the plug from the Time-of-Flight Accessory into Port 3, the Auxiliary Port on the back of the Wireless Smart Gate. The Wireless Smart Gate measures the initial speed of the projectile and the Time-of-Flight Accessory measures total travel time.

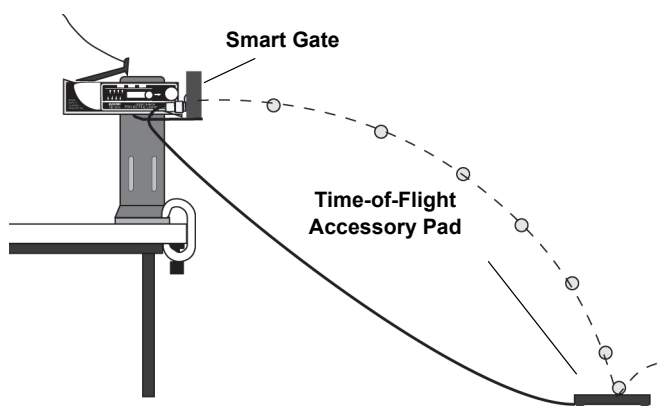

### Using the Wireless Smart Gate with Photogate Tape

High Resolution Photogate Tape (ME-6666) fits through the Photogate Tape Slot on the detector side of the Wireless Smart Gate.

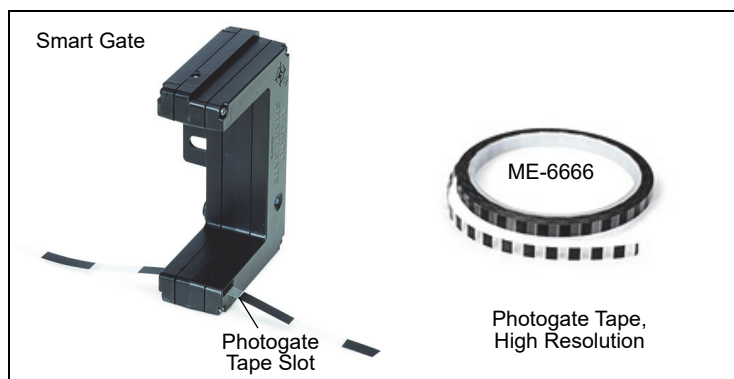

The Photogate Tape is made of a flexible Mylar material that can be cut to any length, and is reusable. The tape is 30 m long with 1cm spacing between bands (edge-to-edge). When the tape is threaded through the Photogate Tape Slot of the Wireless Smart Gate, the student can measure position, velocity, and acceleration with a high degree of accuracy.

**Using the Wireless Smart Gate with a Picket Fence on a Cart**

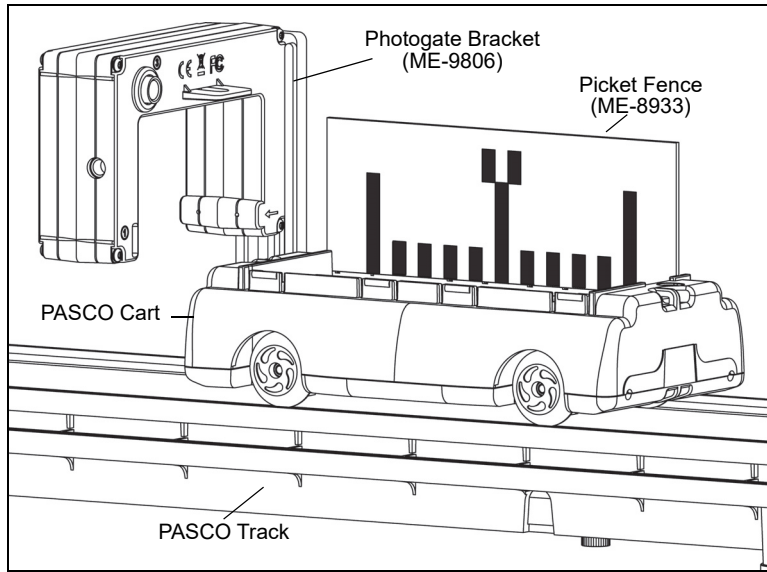

Mount a Five Pattern Picket Fence (ME-9804) or a Smart Timer Picket Fence (ME-8933) to the accessory tray of a PASCO Cart (such as the ME-6950 PAScar). Use a Photogate Mounting Bracket (ME-9806) to mount the Wireless Smart Gate on the side of a PASCO Track (such as the ME-6960 PAStack). Adjust the height of the Smart Gate to match the level of the desired flag pattern on the Picket Fence.

**Using the Wireless Smart Gate with a Photogate Pendulum**

Use a clamp (such as the ME-9506 Pendulum Clamp), a support rod, and string (such as the SE-8050 Braided Physics String) to hang a Photogate Pendulum as shown with the string attached at two points on the Pendulum Clamp,

Use a Mounting Rod (SA-9242 or ME-9483) and a clamp (such as the ME-9507 Multi-Clamp) to Mount the Wireless Smart Gate so that the Photogate Pendulum interrupts the infrared beam as it swings through the Wireless Smart Gate. For more accurate results, arrange the pendulum so that it swings close to the emitter side of the Wireless Smart Gate.

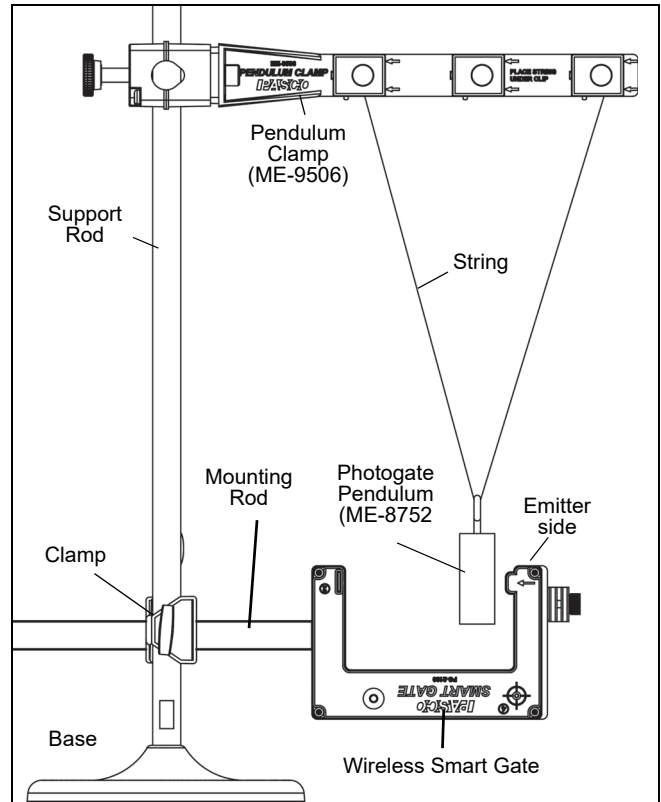

# Software Setup

## Software Help

- In Sparkvue, tap or click the Main Menu icon.
- In the menu, select “Help...” for information about collecting, displaying, and analyzing data.
- In the window that opens is the address of the web page for **Help**. Copy and paste the address into a web browser program to open the Sparkvue User’s Guide web page.

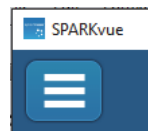

Main Menu icon



SPARKvue “Help” Window

- SPARKvue User’s Guide web page”

## SPARKvue User's Guide

Version: 2.5

🔍





Featuring new wireless lab activities: See the "NEW" SPARKlabs in [Experiments](#).

For information on the new PASCO wireless devices, see: [www.pasco.com/wireless](http://www.pasco.com/wireless).

- In PASCO Capstone, select **PASCO Capstone Help** from the **Help** menu, or press **F1**.

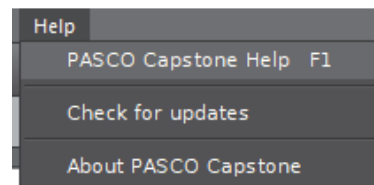

## Bluetooth and Battery LED Information

The Bluetooth LED (light-emitting diode) and the battery LED operate as follows:

Bluetooth LED	Status	Battery LED	Status
Red blink	Ready to pair	Red blink	Low power
Green blink	Connected		

## Indicator LED Information

The Indicator LED on the top of the Wireless Smart Gate shines when the sensor is on and connected to the software and an object blocks the infrared beam entering Port 1 or Port 2. The Indicator LED also shines when a Photogate or a Time-of-Flight Apparatus is attached to the Auxiliary Port (Port 3) and the photogate beam is blocked or a projectile hits the Time-of-Flight pad.

Port	Status	LED Color	Status	LED Color
1	Blocked	Amber	Unblocked	Clear
2	Blocked	Green	Unblocked	Clear
1 & 2	Blocked	Red	Unblocked	Clear
3	Blocked	Red	Unblocked	Clear

Laser Detector Port (Port 4) is a special case. The sensor must be on and Port 4 must be selected in the PASCO Capstone data collection software. If a laser beam shines into Port 4, and the laser beam is blocked, the Indicator LED shines red. If the laser beam is unblocked, the Indicator LED is clear.



## Connect the Sensor Wirelessly via Bluetooth in SPARKvue

1. Turn on the sensor and start SPARKvue.
  - The “choose a path” window opens.

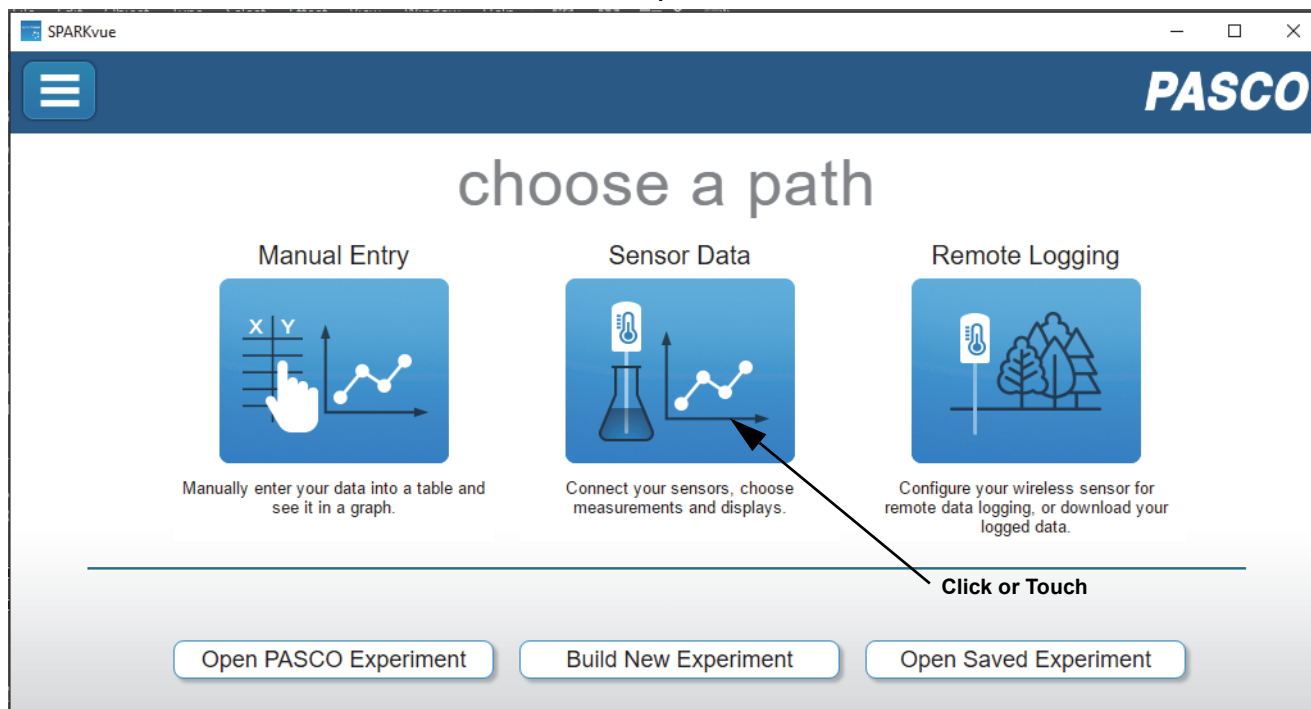

2. To “pair” the Wireless Smart Gate wirelessly to the computing device (e.g., computer or tablet), click or touch “Sensor Data” in the “choose a path” window.
  - The “Sensor Data Configuration” screen opens.
3. In the “Sensor Data Configuration screen”, look in the “Connected Devices” list. Touch or click to select the correct address that matches the Device ID XXX-XXX number found on the Wireless Smart Gate.
  - A message confirms that the sensor is being connected.
  - Next, in the “Sensor Data Configuration” screen, “Wireless Smart Gate” appears in the “Select Measurement for Templates” panel,

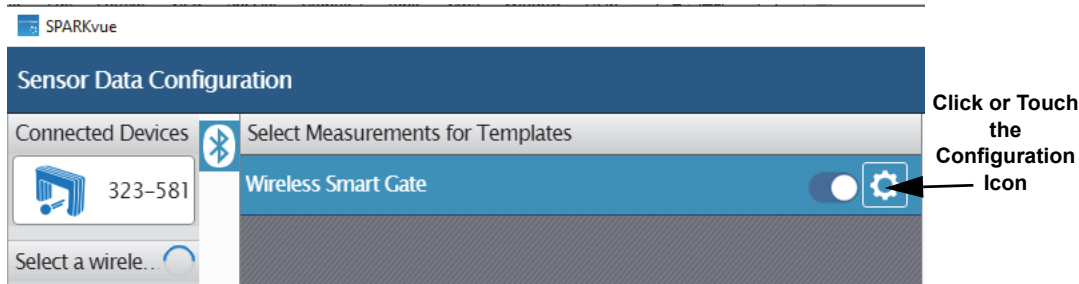

4. Click or Touch the “gear-shaped” Configuration Icon
  - The “Assign SmartGate” screen is revealed.

# Assign SmartGate- Smart Gate Only

The three choices are:

- “Smart Gate Only”
- “Smart Gate and Auxiliary Port”
- “Auxiliary Port Only”

## Smart Gate Only

Click or touch the menu arrow for “Smart Gate Only” to show the various timer choices.

See the descriptions that follow.

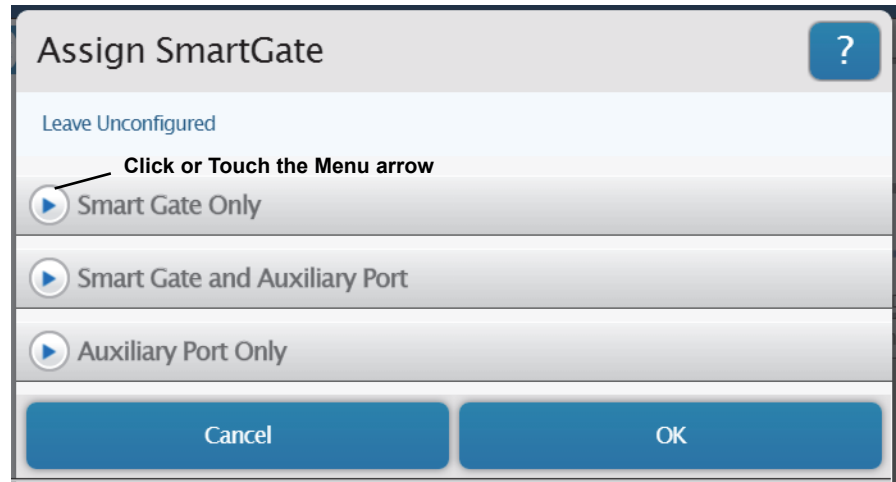

Assign SmartGate Choices

## 1. Smart Gate Only - Smart Gate Timer

- Click or touch “Smart Gate Timer” and then click or touch “OK” to accept the choice and close the dialog.
- The “Select Measurements for Templates” panel is revealed.
- The panel shows “Speed Between Gates” as the default choice.
- This measurement is based on the time from when the first Detector Port beam is blocked until the second Detector Port beam is blocked.

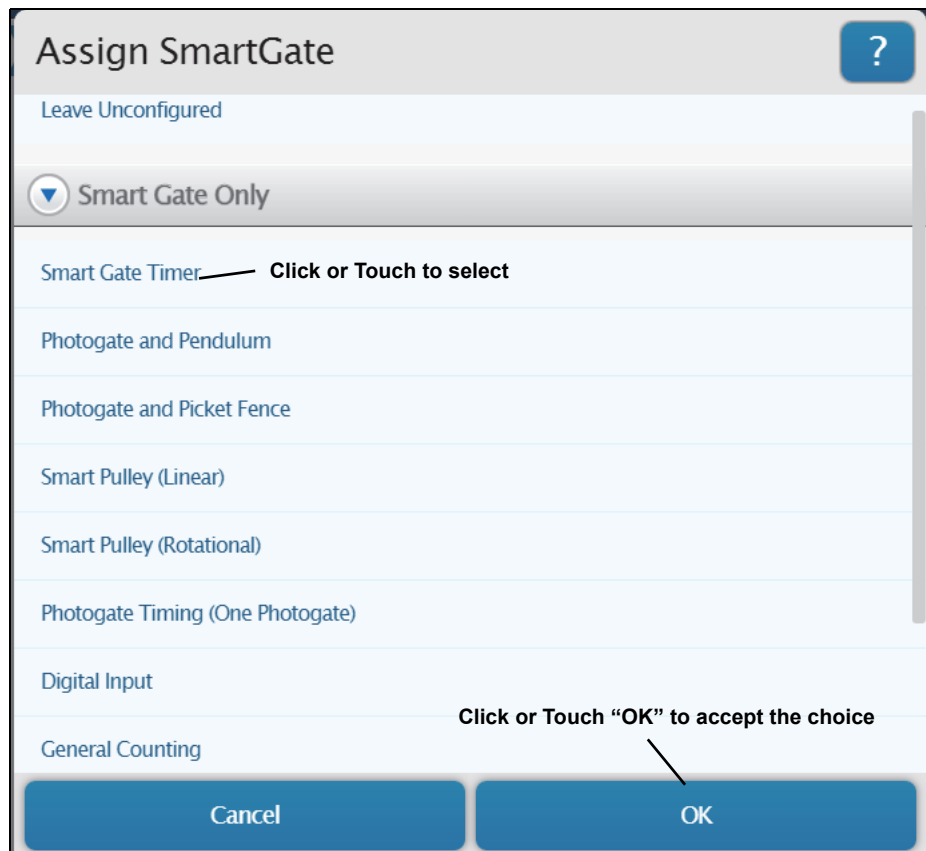

Smart Gate Only- Timer Choices

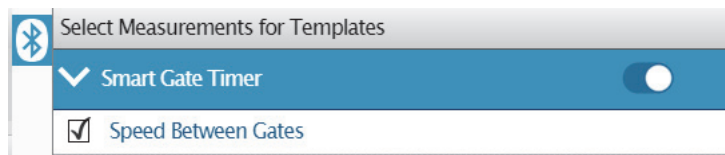

Smart Gate Timer Measurements

## 2. Smart Gate Only - Photogate and Pendulum

1. Click or touch “Photogate and Pendulum” and then click or touch “OK” to accept the choice and close the dialog. The “Edit Timer Properties:” panel is revealed.

- If the Pendulum Width needs to be changed, highlight the default value in the “Edit Timer Properties:” panel and enter the actual value.

2. Click or touch “OK” to accept the change and close the panel.

- The “Select Measurements for Templates” panel is revealed.

- The panel shows “Period” and “Velocity” with “Period” as the default choice. This measurement gives the amount of time for one full pendulum swing. It begins with the first interruption of the infrared beam and ends with the third interruption. The “Velocity” measurement gives the speed and direction of the pendulum based on the time between Detector Port 1 and Detector Port 2. Direction is based on which Detector Port is interrupted first.

## 3. Smart Gate Only - Photogate and Picket Fence

1. Click or touch “Photogate and Picket Fence” to select it and then click or touch “OK” to accept the choice and close the dialog.

- The “Edit Timer Properties” panel is revealed. If the Flag Spacing on the Picket Fence needs to be changed, highlight the default value in the panel and enter the actual value.

2. Click or touch “OK” to accept the change and close the dialog.

- The “Select Measurements for Templates” panel is revealed.

- The panel shows “Position”, “Velocity”, and “Acceleration” with “Position” as the default choice. This measurement gives the amount of distance moved based on the “Flag Spacing” for the Picket Fence. The “Velocity” measurement gives the speed and direction of the Picket Fence based on the time between Detector Port 1 and Detector Port 2. Direction is based on which Detector Port is interrupted first. The “Acceleration” measurement is based on the “Change in Velocity” per unit of time.

Photogate and Picket Fence Measurements

#### 4. Smart Gate Only - Smart Pulley (Linear)

1. Click or touch “Smart Pulley (Linear)” to select it and then click or touch “OK” to accept the choice and close the dialog.

- The “Edit Timer Properties” panel is revealed.

- If the Spoke Arc Length for the Super Pulley needs to be changed, highlight the default value in the “Edit Timer Properties:” panel and enter the actual value.

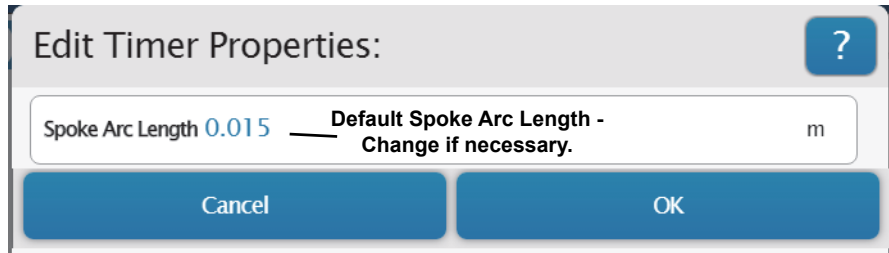

- **Note**, the Super Pulley’s Outside Circumference is 16 cm or 0.16 m. The Super Pulley has ten spokes, so **the Spoke Arc Length is one-tenth of the circumference**, or 0.016 m. However, the Super Pulley’s Groove Circumference is 15 cm, or 0.015 m for the Spoke Arc Length. If the Super Pulley measures a linear distance by rolling on the outer edge of the pulley, use 0.016 m as the Spoke Arc Length. However, if the Super Pulley measures a linear distance traveled by a string or thread in its groove, use 0.015 m as the Spoke Arc Length.

2. Click or touch “OK” to accept the change and close the dialog.

- The “Select Measurements for Templates” panel is revealed.

- The panel shows “Position”, “Velocity”, and “Acceleration” with “Position” as the default choice. This measurement gives the amount of distance moved based on the “Spoke Arc Length” of the Super Pulley. The “Velocity” measurement gives the speed and direction of the Super Pulley based on the time between Detector Port 1 and Detector Port 2. Direction is based on which Detector Port is interrupted first. The “Acceleration” measurement is based on the “Change in Velocity” per unit of time.

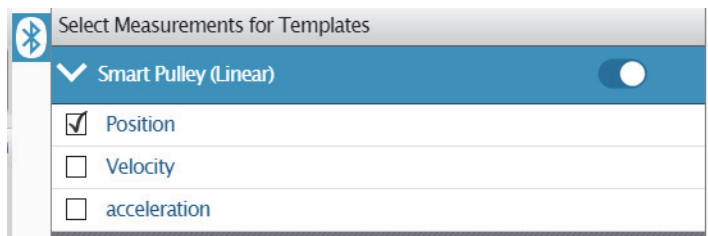

#### 5. Smart Gate Only - Smart Pulley (Rotational)

1. Click or touch “Smart Pulley (Rotational)” and then click or touch “OK” to accept the choice and close the dialog. The “Edit Timer Properties” panel is revealed.

- If the Spoke Angle Spacing on the Super Pulley needs to be changed, highlight the default value in the “Edit Timer Properties:” panel and enter the actual value.

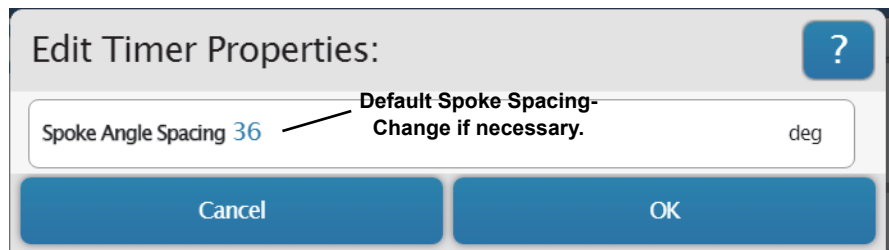

- Note, the Super Pulley’s Spoke Angle Spacing is 36 degrees.

2. However, If a different pulley is used, highlight the default value and enter the value for the pulley’s Spoke Angle Spacing.

3. Click or touch “OK” to accept the change and close the dialog.

- The “Select Measurements for Templates” panel is revealed.

- The panel shows “Position”, “Velocity”, and “Acceleration” with “Position” as the default choice. This measurement gives the amount of angular distance moved based on the “Spoke Arc Length” of the Super Pulley. The “Velocity” measurement gives the angular speed and direction of the Super Pulley based on the time between Detector Port 1 and Detector Port 2.

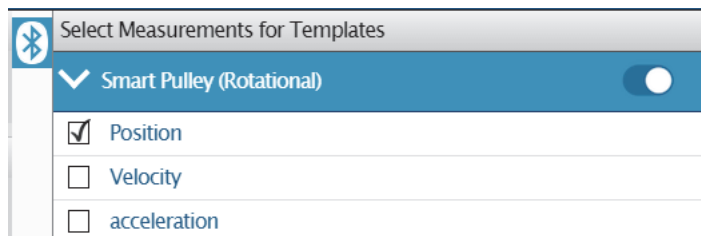

Direction is based on which Detector Port is interrupted first. The “Acceleration” measurement is based on the “Change in Velocity” per unit of time.

## 6. Photogate Timing (One Photogate)

- This option assumes that a flag will be passed through the beam between Emitter Port 1 and Detector Port 1.

- Click or touch “Photogate Timing (One Photogate)” to select it and then click or touch “OK” to accept the choice and close the dialog.

- The “Edit Timer Properties” panel is revealed. The “Flag Length” default value is 0.025 m.

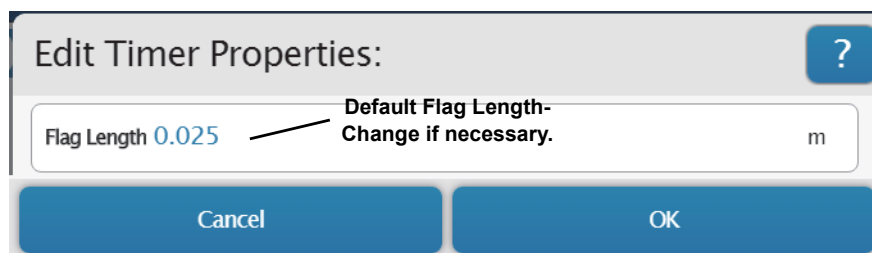

- However, if the Length of the flag you are using to interrupt the Wireless Smart Gate is a different length, highlight the default value in the panel and enter the flag’s actual value.

- Click or touch “OK” to accept the change and close the dialog.

- The “Select Measurements for Templates” panel is revealed. The panel shows “Time In Gate” and “Velocity In Gate” with “Time In Gate” as the default choice. This measurement gives the amount of time that the Wireless Smart Gate beam for Detector Port 1 was blocked. The “Velocity In Gate” measurement gives the speed and direction of the flag used to block the beam based on the Flag Length and the Time In Gate.

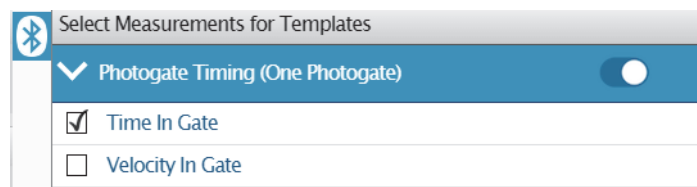

## 7. Digital Input

- This option assumes that a flag will be passed through the beam between Emitter Port 1 and Detector Port 1.

- Click or touch “Digital Input” to select it and then click or touch “OK” to accept the choice and close the dialog.

- The “Select Measurements for Templates” panel is revealed.

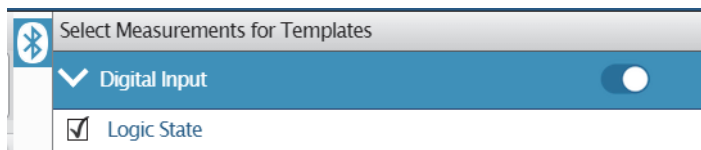

- The panel shows “Logic State” as the only choice. The “Logic State” is “0.00” if the gate is unblocked and “1.00” if the gate is blocked. The example Table shows that this measurement records the Logic State (unblocked or blocked) and the time when the Logic State happened.

	Logic State	Time (s)
2	0.00	3.669
3	1.00	5.403
4	0.00	18.733
5	1.00	22.774
6	0.00	27.267
7		
8		
9		

## 8. General Counting

- This option assumes that a flag or object will be passed through the beam between Emitter Port 1 and Detector Port 1.

- Click or touch “General Counting” to select it and then click or touch “OK” to accept the choice and close the dialog.

- The Edit Timer Properties:” panel shows the default “Count Time Interval” is 1 (one) second (s).

- However, if you are using a different amount of time for counting, highlight the default value in the “Edit Timer Properties:” panel and enter the actual value.

**Edit Timer Properties:**

Count Time Interval 1 — Default Time Interval— Change if necessary. s

Cancel OK

- Click or touch “OK” to accept the change and close the dialog.

- The “Select Measurements for Templates” panel is revealed. The panel shows “Pulse Count” as the default choice. This measurement gives the number of times per “Count Time Interval” that the Wireless Smart Gate beam for Detector Port 1 was blocked.

Select Measurements for Templates

General Counting

Pulse Count

## Assign SmartGate- Smart Gate and Auxiliary Port

### 1. Smart Gate and Auxiliary Port - Time of Flight Example

- The second choice for Assign Smart Gate Is “Smart Gate and Auxiliary Port”.
- In the Hardware Setup section, see Mounting the Wireless Smart Gate on a PASCO Projectile Launcher.**

- Connect a Time-of-Flight Accessory Pad (ME-6810A) to Port 3, the Auxiliary Port on the Wireless Smart Gate.

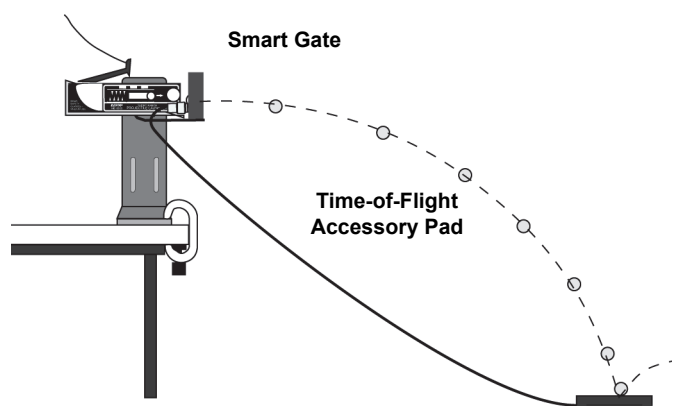

2. Click or touch the menu arrow for “Smart Gate and Auxiliary Port” to show the various choices.
- Click or touch “Time of Flight” to select that choice.
3. Click or touch “OK” to accept the choice and close the dialog.

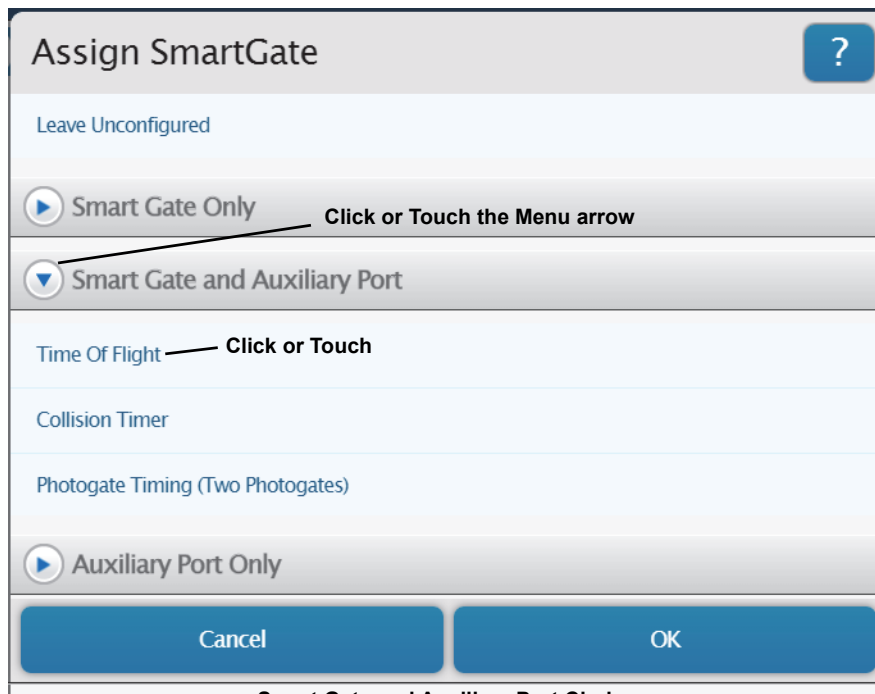

Smart Gate and Auxiliary Port Choices

- The “Edit Timer Properties” panel is revealed. In the “Edit Timer Properties” panel, the “Photogate Spacing” default value is 0.1 m.

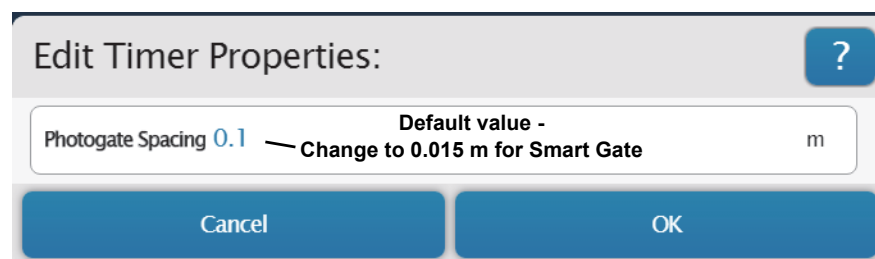

4. However, if you are using a Smart Gate, then the “Photogate Spacing” is 0.015 m. Highlight the default value in the “Edit Timer Properties:” panel and enter the actual value. Click or touch “OK” to accept the change and close the dialog.

- The “Select Measurements for Templates” panel is revealed.

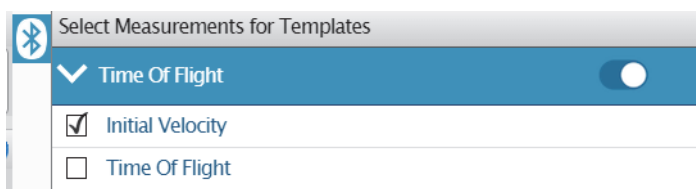

- The panel shows “Initial Velocity” and “Time of Flight” with “Initial Velocity” as the default choice. This measurement gives the velocity of the projectile fired by the Projectile Launcher as calculated based on the Photogate Spacing and the time from when the projectile blocked “Port 1” until it blocked “Port 2”.
- The “Time Of Flight” measurement gives the time from when the projectile blocks “Port 1” of the Smart Gate until the projectile hits the Time-Of-Flight Accessory pad.

## 2. Smart Gate and Auxiliary Port - Collision Timer

One of the experiments for “Collision Timer” is the “Impulse - Collision” Experiment. In this experiment, a cart on a slightly inclined track collides with a force sensor and the impulse during the collision is recorded. The cart’s velocity just before the collision and the velocity just after the collision are measured by the Wireless Smart Gate. The mass of the cart and the difference in velocity (before and after) give the change in momentum during the collision. Is the impulse equal to the change in momentum?



1. Click or touch “Collision Timer” and then click or touch “OK” to accept the choice and close the dialog.

- The “Edit Timer Properties” panel is revealed. The “Flag Length” default value may need to be changed.

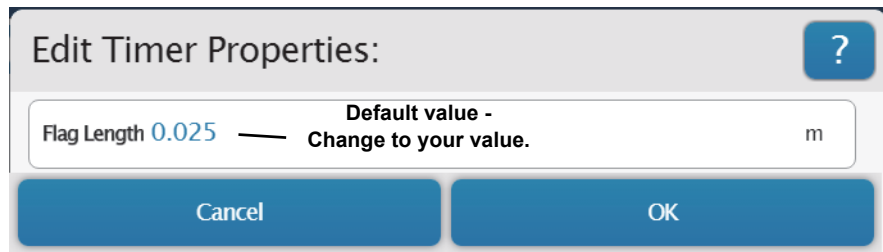

2. Measure the length of the “flag” or the Picket Fence you are using. Highlight the default value in the “Edit Timer Properties:” panel and enter the actual value. Click or touch “OK” to accept the change and close the dialog.

- The “Select Measurements for Templates” panel is revealed. The panel shows “Velocity 1” and “Velocity 2” with “Velocity 1” as the default choice. This measurement gives the velocity of the PASCO Cart as calculated based on the Flag Length and the time from when the Flag blocked “Detector Port 1” until it blocked “Detector Port 2”. Direction is determined based on which port was blocked first. The “Velocity 2” measurement is the same and is designed to give the velocity of the cart after it collides with the force sensor.

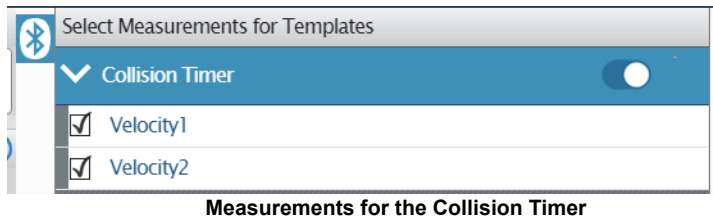

3. Click or touch the box next to “Velocity 2”.

Another experiment for Collision Timer is “Conservation of Momentum” (In an Explosion or a Collision). In an “Explosion”, two carts, each with a picket fence (such as the ME-9804 Five Pattern Picket Fence) start at rest next to each other in the middle of a track. Put the plunger of one cart at one of the three positions. Move the carts together so that the end of the plunger on one cart touches the end of the other cart. Mount the Wireless Smart Gate near one end of the track. Mount an Accessory Photogate near the other end of the track. Connect the Accessory Photogate to Auxiliary Port (Port 3) on the Wireless Smart Gate. Start recording data and then release the plunger so that the carts “explode” away from each other. The total momentum before the explosion is zero. Use your data to determine whether the momentum is conserved.



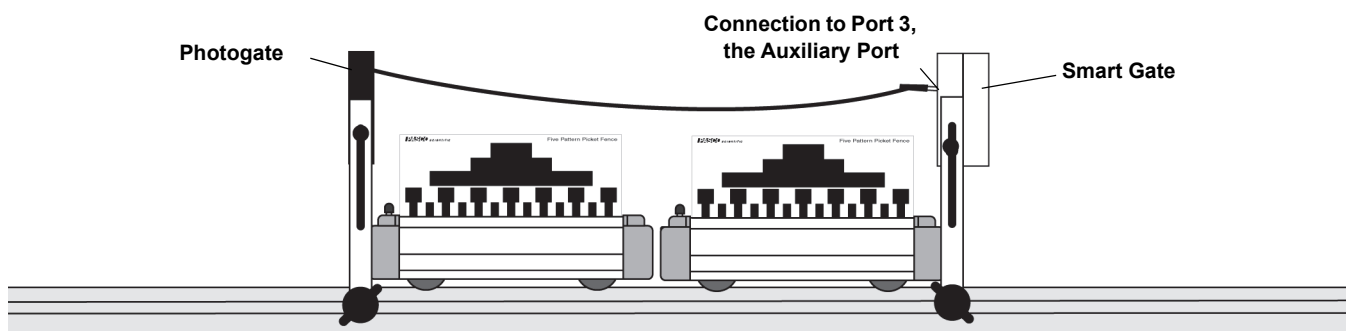

In a “Collision”, the carts with magnetic bumpers start at opposite ends of the track, move toward each other, and collide between the Accessory Photogate and Wireless Smart Gate. Start recording data and then push the two carts toward each other so that they collide near the middle of the track. The magnetic bumpers force each cart to rebound and pass through The Accessory Photoate and the Wireless Smart Gate again. Use your data to determine whether the total momentum after the collision is equal to the total momentum before the collision.

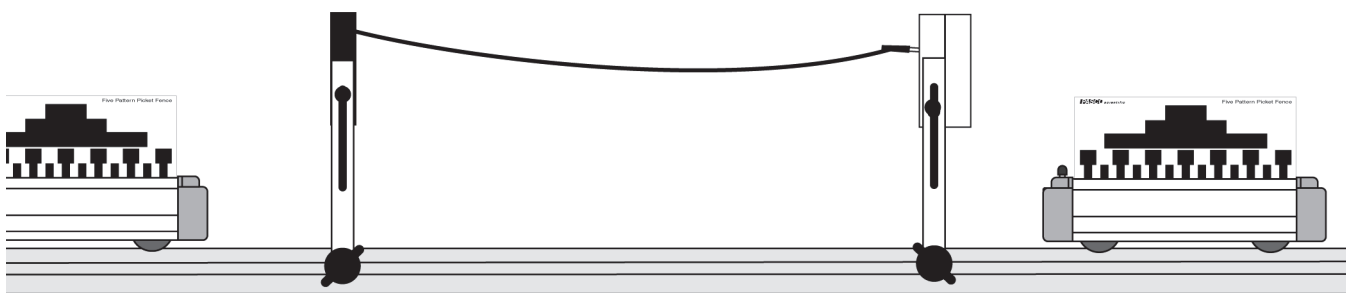

### 3. Smart Gate and Auxiliary Port - Photogate Timing (Two Photogates)

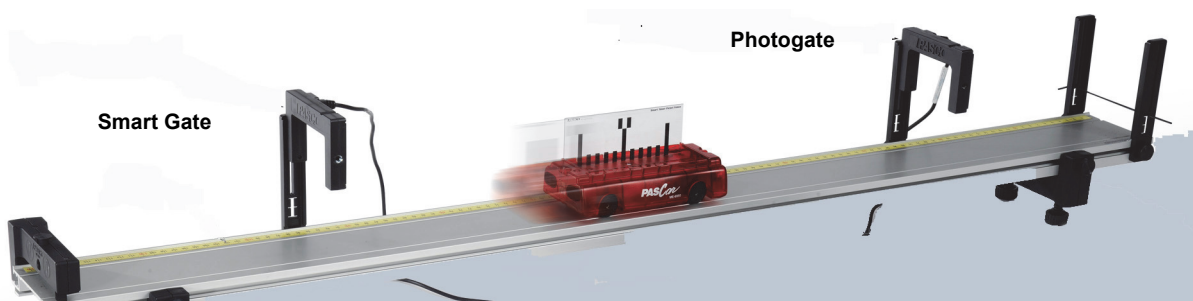

The “Photogate Timing (Two Photogates)” is designed for experiments such as “Acceleration Down an Inclined Plane”. In this experiment, a cart starts at the top of an inclined PASCO track. When released, the cart accelerates down the track and its velocity is measured when it passes through the Wireless Smart Gate and again when it passes through the second photogate. The second photogate should be a PASCO Photogate Head (ME-9498A) or the PASCO Accessory Photogate (ME-9204B). Connect the plug from the second photogate into Port 3, the Auxiliary Port on the back of the Wireless Smart Gate. In this mode, Detector Port 1 on the the Wireless Smart Gate will make measurements and so will the second photogate.

1. Click or touch “Photogate Timing (Two Photogates)” to select it and then click or touch “OK” to accept the change and close the dialog. The “Edit Timer Properties” panel is revealed. The “Flag Length” default value may need to be changed.

2. Measure the length of the “flag” on the Picket Fence you are using. Highlight the default value in the “Edit Timer Properties:” panel and enter the actual value.
3. Also, the “Photogate Spacing” default value may need to be changed. Measure the distance separating the Wireless Smart Gate and the second photogate. Highlight the default value in the “Edit Timer Properties:” panel and enter the actual value. Click or touch “OK” to accept the change and close the dialog. The “Select Measurements for Templates” panel is revealed.

- The panel shows seven measurements with “Time In Gate<sub>1</sub>” as the default choice. This measurement gives the time that the flag of the picket fence blocked Detector Port 1.
- “Velocity In Gate<sub>1</sub>” is the velocity of the cart based on the flag length and the time that Detector Port 1 was blocked.
- The “Time in Gate2” and “Velocity in Gate2” are based on the flag length and the time that the flag blocked the second photogate.

- The “Time Between Gates”, “Velocity Between Gates”, and “Acceleration Between Gates” all depend on the Photogate Spacing distance and the time between when the Wireless Smart Gate was blocked and the second photogate was blocked

## Assign SmartGate- Auxiliary Port Only

The third choice for “Assign Smart Gate” is

- “Auxiliary Port Only”

### Auxiliary Port Only

Click or touch the menu arrow for “Auxiliary Port Only” to show the choice (Free Fall Adapter).

Go to [www.pasco.com](http://www.pasco.com) to see the description of the ME-9207B Free Fall Adapter.

Assign SmartGate Choices

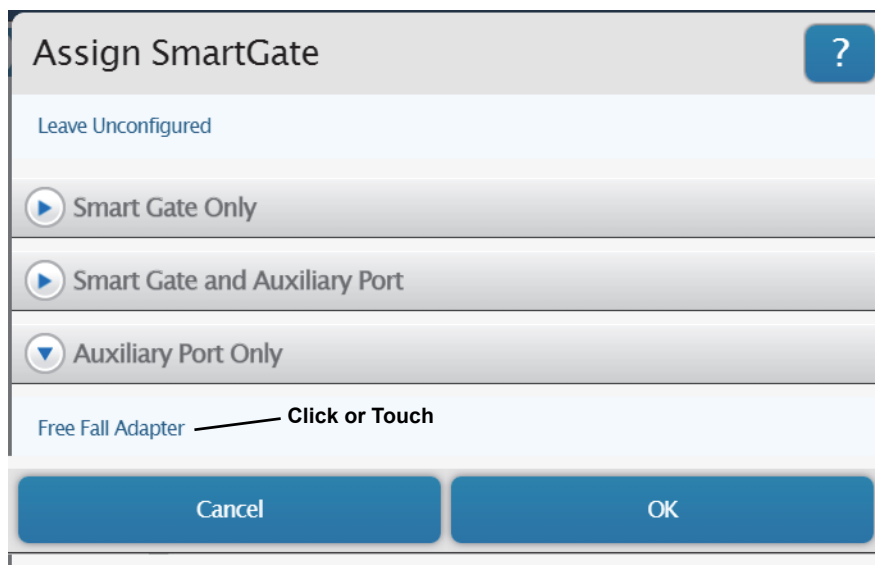

### 1. Auxiliary Port Only - Free Fall Adapter

1. Connect the plug from the PASCO Free Fall Adapter to Port 3, the Auxiliary Port on the Wireless Smart Gate. The Free Fall Adapter is designed to hold a metal ball at a height above the “receptor pad”. When the ball is released, timing begins. When the ball hits the pad, timing stops. Use the instructions that come with the Free Fall Adapter to set it up for measurement.

2. Click or touch “Free Fall Adapter” and then click or touch “OK” to accept the choice and close the dialog. The “Edit Timer Properties” panel opens. The “Height Of Fall” default value is 1 m.

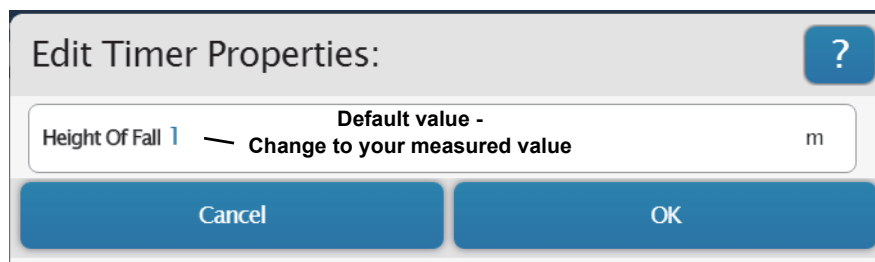

3. After you set up the Free Fall Adapter, carefully measure the distance from the bottom of the ball to the top of the receptor pad. Highlight the default value in the “Edit Timer Properties:” panel and enter your actual value. Click or touch “OK” to accept the change and close the dialog.

- The “Select Measurements for Templates” panel is revealed.

- The panel shows “Time Of Fall” and “acceleration,” with “Time Of Fall” as the default choice. This measurement gives the time for the ball to fall and “acceleration” is calculated based on the “Time of Fall” and the “Height Of Fall”.

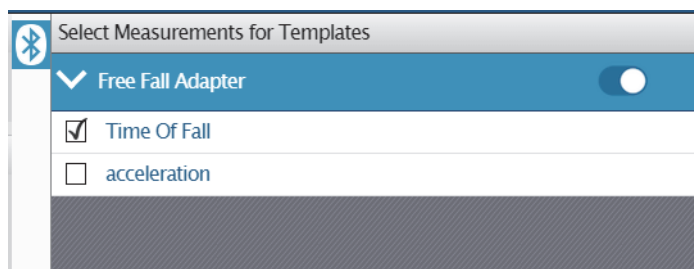

$$y = \frac{1}{2}gt^2$$

$$\frac{2y}{t^2} = g$$

## Connect the Sensor Wirelessly in PASCO Capstone

1. Turn on the sensor and start the software. In the PASCO Capstone Tools palette, click the “Hardware Setup” icon to open the Hardware Setup panel.

### Hardware Setup Icon



- If no device is connected, the panel says “Searching for wireless devices...”. and, below that, “Please connect to an interface or wireless device.” The panel shows the “Available Wireless Devices”.
2. Under “Available Wireless Devices,” click the sensor that matches the XXX-XXX Device ID number that is on one side of the Wireless Smart Gate.
- A “Connecting to the sensor” message appears briefly.
  - The Hardware Setup panel changes to show the image of the Wireless Smart Gate including Port 3, the Auxiliary Port. and Port 4, the Laser Detector Port.

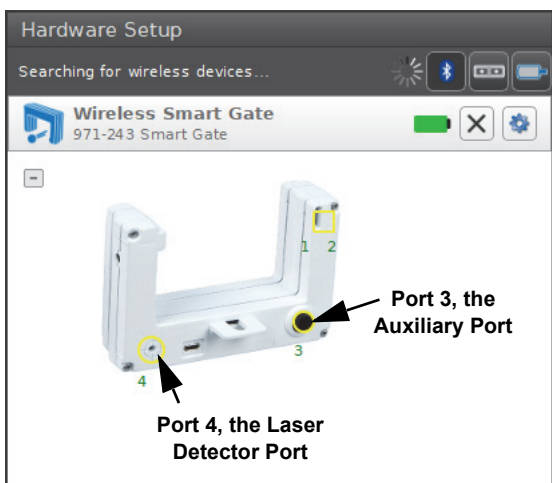

- The default setup choice is “Smart Gate (Single Flag)”.

### Smart Gate (Single Flag) Setup

1. Click the “Hardware Setup” icon in the Tools palette to close the “Hardware Setup” panel.
2. Click the “Timer Setup” icon in the tools palette to open the Timer Setup panel.

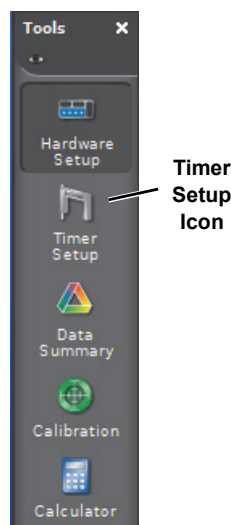

- The Timer Setup panel is revealed.

## Timer Setup Panel: What Everything means in the Timer Setup Wizard.

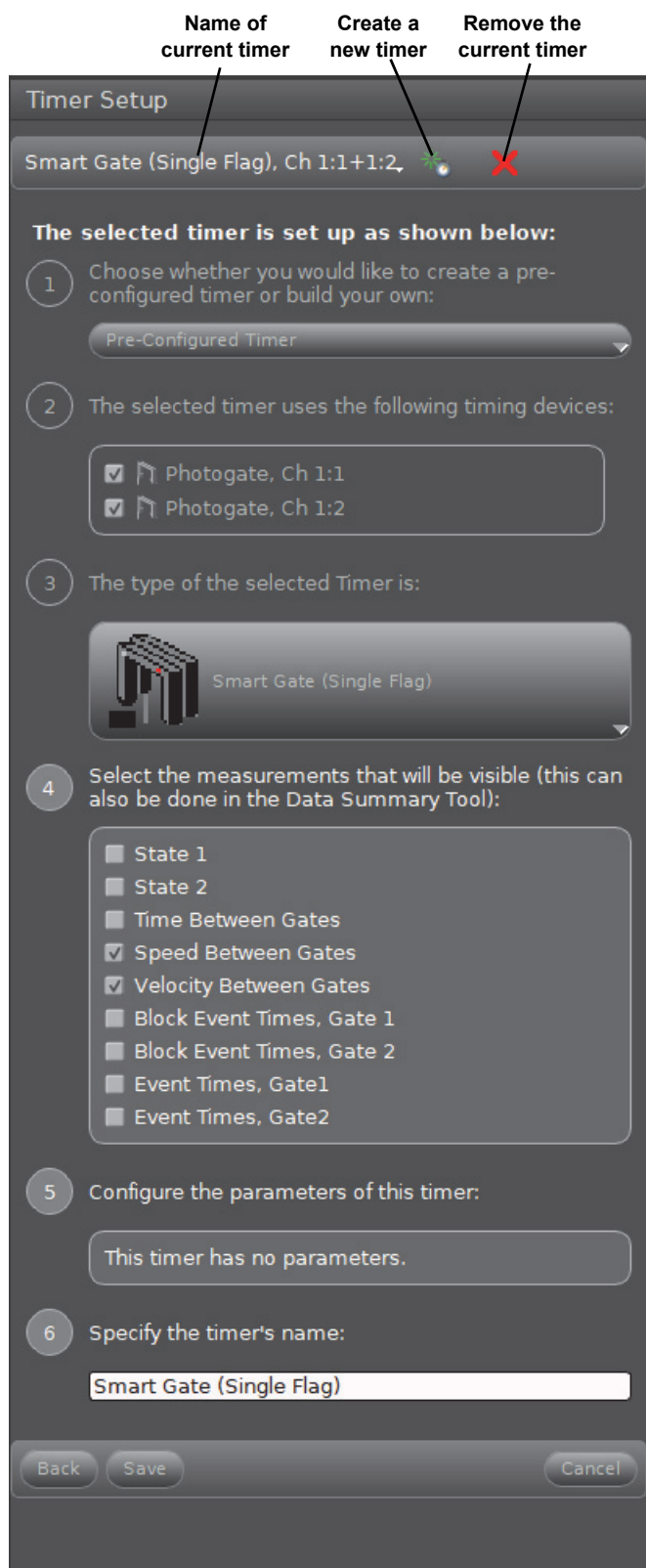

- There are usually six steps (1 through 6) in the Timer Setup panel. The steps show the setup of the selected timer.

### Default choice:

Click the name of the current timer to see other timers, if there are any.

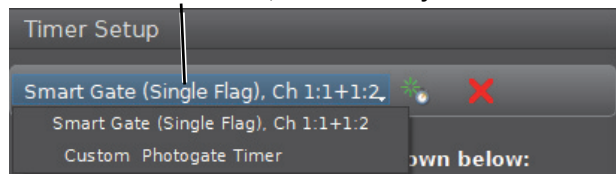

**Smart Gate (Single Flag), Ch 1:1+1:2** is the name of the current timer. It shows that on the Wireless Smart Gate “Ch 1”, Port 1 and Port 2 are the default timing devices. Click the small green star shaped button to create a new timer. Click the red “X”-shaped button to remove the selected timer. Click anywhere on the current timer’s name to see the names of other timers, if any, that could be selected.

When reviewing a timer in the Timer Setup Wizard, Step 1, Step 2, and Step 3 are not “active” which means that there is nothing to change.

Step 4 is a list of measurements that will be visible (selectable) in whatever Display is used. “Speed Between Gates” and “Velocity Between Gates” are already chosen. You can uncheck the chosen items and/or check any of the other items.

**State 1:** This is “0.00” if detector Port 1 is unblocked and “1.00” if detector Port 1 is blocked.

**State 2:** The same as “State 1” but for detector Port 2.

**Time Between Gates:** The time from when the first detector port is blocked until the second detector port is blocked.

**Speed Between Gates:** The speed of the object whose motion is being measured based on the distance between Detector Port 1 and Detector Port 2 (1.5 cm) divided by the “Time Between Gates”.

**Velocity Between Gates:** The speed and direction of the object whose motion is being measured. If Port 1 is blocked first, then the direction is “positive”. If Port 2 is blocked first, then the direction is “negative.”

**Block Event Times, Gate 1:** The amount of time that Port 1 is blocked.

**Block Event Times, Gate 2:** The amount of time that Port 2 is blocked.

**Event Times, Gate 1:** The time from when data recording started until Port 1 is blocked.

**Event Times, Gate 2:** The time from when data recording started until Port 2 is blocked.

Step 5: Click here to enter parameters, if any, such as the length of a flag or the spacing between photogates,

Step 6: Highlight the text in the edit window to enter a new name for the timer.

Click **“Save”** if you want to save your changes. Click **“Cancel”** to remove your changes and revert to the original setup. Click the **“Timer Setup”** Icon to close the Timer Setup panel.

## Record and Display Data in PASCO Capstone

### First, Setup a Display for a “Smart Gate (Single Flag)”

By default, PASCO Capstone shows a “workbook” page with eight pre-configured “QuickStart” page templates

- The “Part A” illustration below shows the left half of the “workbook” page and the Tools palette.
- The “Part B” illustration below shows the right half of the “workbook” page and ten of the fourteen choices in the Displays palette.

The screenshot displays the PASCO Capstone software interface. The top window is titled "Master" and "Page #1".

**Part A (left half of workbook page)**  
 This section shows the left half of the workbook page. It features a "Tools" palette on the left with icons for Hardware Setup, Data Summary, Calibration, and Calculator. The main area contains the text "Part A (left half of workbook page)" and "Drag a display onto the page or choose one of the QuickStart page templates below." Below this text are four QuickStart templates: a table and graph, a table with two digits (1.23) and a graph, a table with two graphs, and a table with two graphs.

**Part B (right half of workbook page)**  
 This section shows the right half of the workbook page. It features a "Displays" palette on the right with icons for Graph, Table, Digits, Scope, FFT, Meter, Bar Meter, Histogram, Video Analysis, and Image. The main area contains the text "Part B (right half of workbook page)" and "Templates below." Below this text are four display templates: a two-digit display (1.23), a large letter 'A' and a graph, a table with two graphs, and a table with four graphs.

1. For the example of “Smart Gate (Single Flag)”, click the “Two Digits Display” template to select it.
2. In the displays, click the “Select Measurement” menu to see the available choices. In one display select “Speed Between Gates”. In the other display, select “Velocity Between Gates”.

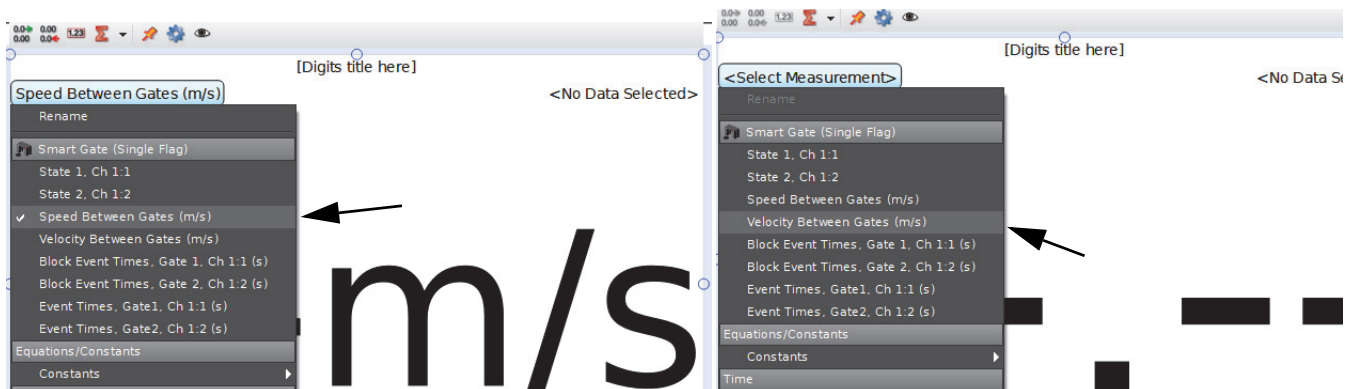

- On the workbook page, the displays can be moved and re-sized as needed.

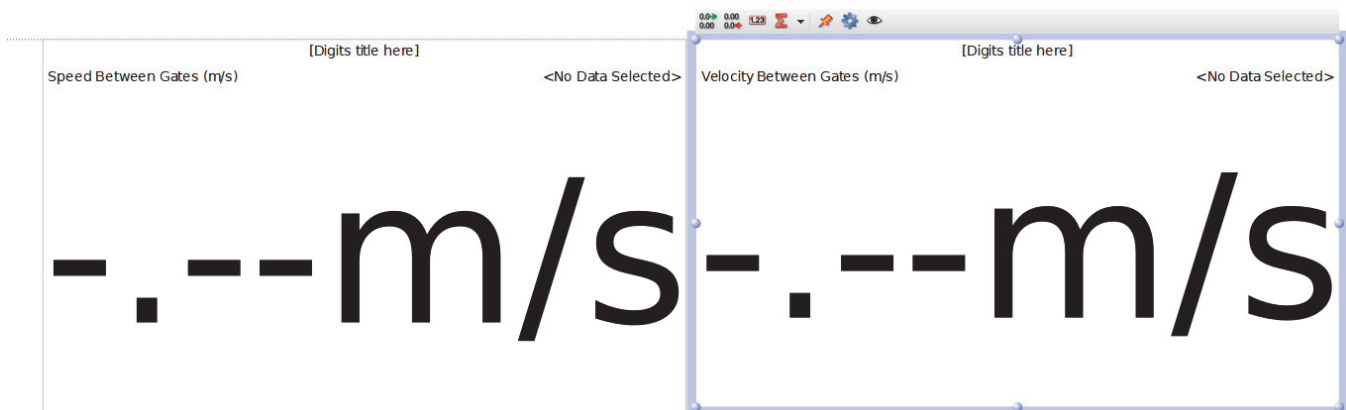

### Next, Record Data

- Just below the workbook page is the “Controls” palette. The “Record” button is near the left end of the palette.

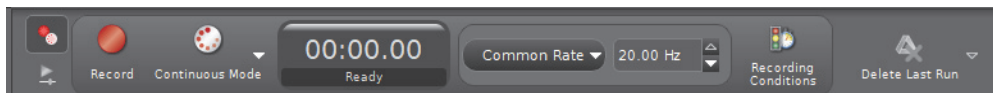

1. Click the “Record” button to begin data recording.
- The experiment clock will show the elapsed time. The “Record” button changes to a “Stop” button.
2. Watch the digits displays as you pass a finger back and forth through the Wireless Smart Gate.
- The “Speed Between Gates” will show a positive value. The “Velocity Between Gates” will show a positive value or a negative value depending on which direction your finger is moving when it goes through the sensor.
3. Click the “Stop” button to end data recording.

## Next - Special Features of the Wireless Smart Gate

- In the “Hardware Setup” panel, the Wireless Smart Gate picture shows the location of Port 3, The Auxiliary Port and Port 4, The Laser Detector Port.

### Port 3, Auxiliary Port Setup

- Click the image of Port 3 to open the menu of choices that can be connected to Port 3, the Auxiliary Port.

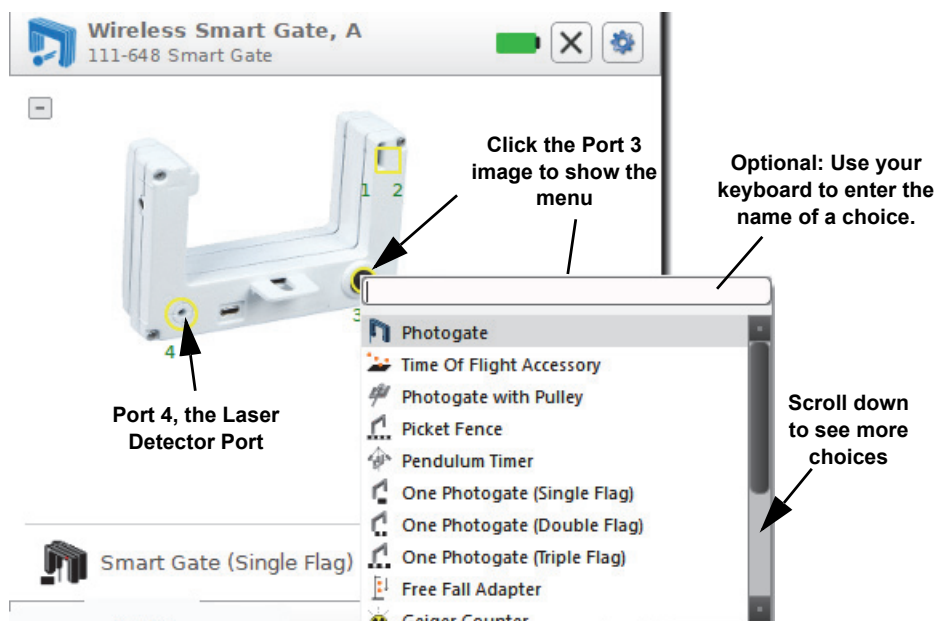

- The choices from the **Port 3, Auxiliary Port** menu are as follows:

Photogate	One Photogate (Single Flag)	General Counter
Time of Flight Accessory	One Photogate (Double Flag)	Drop Counter
Photogate with Pulley	One Photogate (Triple Flag)	Flow Rate Sensor
Picket Fence	Free Fall Adapter	4 to 1 Adapter
Pendulum Timer	Geiger Counter	

- The choices include timing devices (e.g., “Photogate”, “Time of Flight Accessory”), pre-configured timers (e.g., “Picket Fence”, “One Photogate (Triple Flag)”), and sensors connected via a TRS phono plug (e.g., “Free Fall Adapter”, “Geiger Counter”).

### Port 3, Auxiliary Port - Example Setup for Photogate

- Connect a Photogate (such as ME-9204B Accessory Photogate or ME-9498A Photogate Head) to Port 3, the Auxiliary Port.
- Next, click the image of Port 3 to open the menu of choices. Select Photogate from the menu.



- The Hardware Setup panel changes to show the Photogate icon under Port 3.

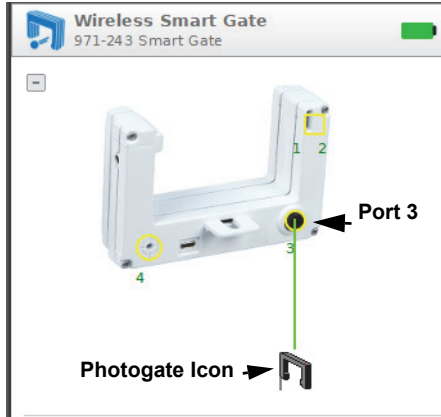

- Click the Hardware Setup icon to close the Hardware Setup panel. Click the Timer Setup icon to re-open the Timer Setup panel.

- The Timer Setup panel is revealed.

- Click the small green star-shaped button to create a new timer that is labeled “New Timer” by default.

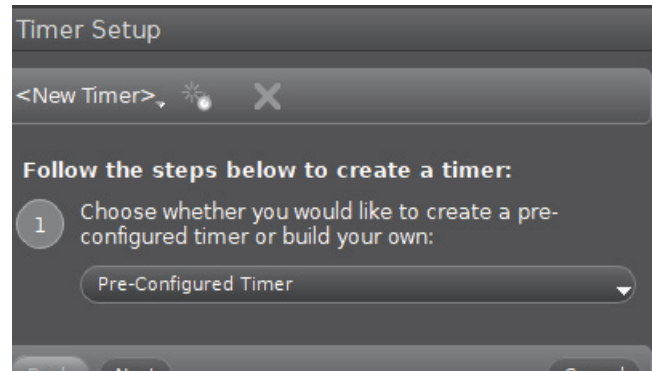

- Step 1 is now active. You can choose whether to create a pre-configured timer or build your own.
- Click the Pre-Configured Timer menu to see the choices.

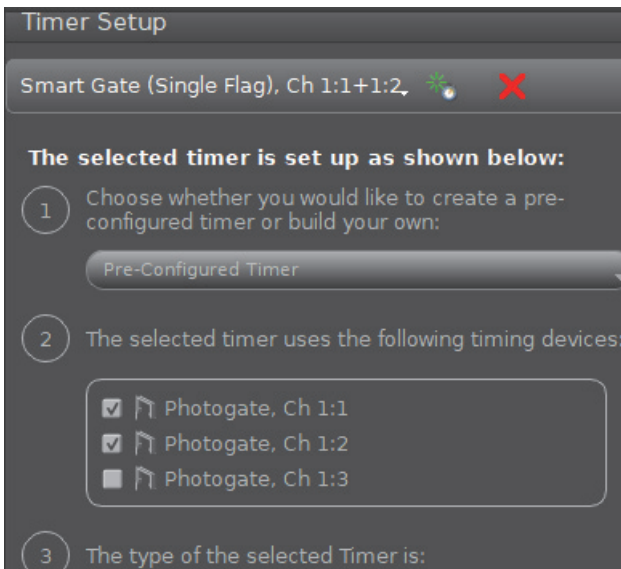

- The updated Timer Setup panel shows something different under Step 2 “. There is another photogate, “**Photogate, Ch 1:3**”. However, Step 2 is not yet active and **Photogate, Ch 1:3** is not selected. The rest of the Timer Setup panel is unchanged.
- You will need to build a new timer in order to use the extra photogate along with the Smart Gate. One option is to create a new pre-configured timer that uses features of other timers. Another option is to create a custom timer.

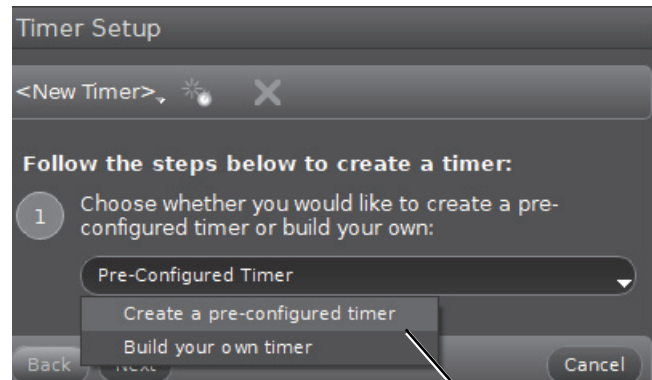

- Select Create a pre-configured timer.

- Step 2 is now active. Also, the new photogate (**Photogate, Ch 1:3**) has a checkmark.

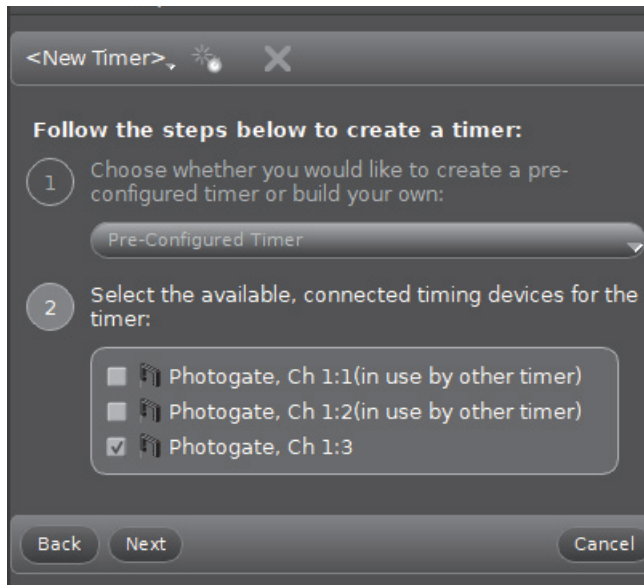

- Put a checkmark in front of the first photogate (**Photogate, Ch 1:1**). Click Next.

  - Step 3 becomes active and it shows a warning message about “previously configured devices”.

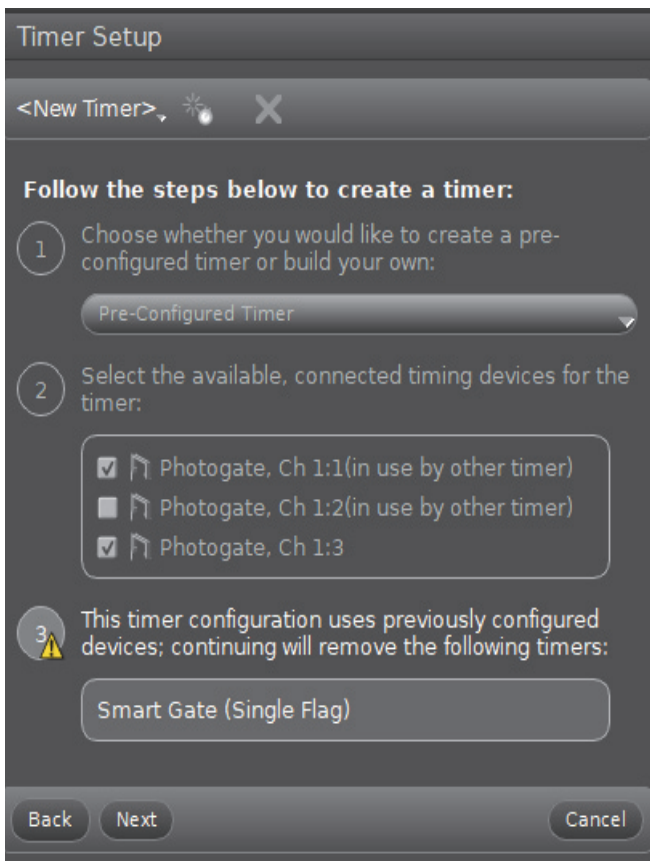

- Ignore the warning and click “Next” to open Step 4.
- Step 4 allows you to select the type of timer you would like to create. Step 4 also reveals the “Select a Timer” menu.

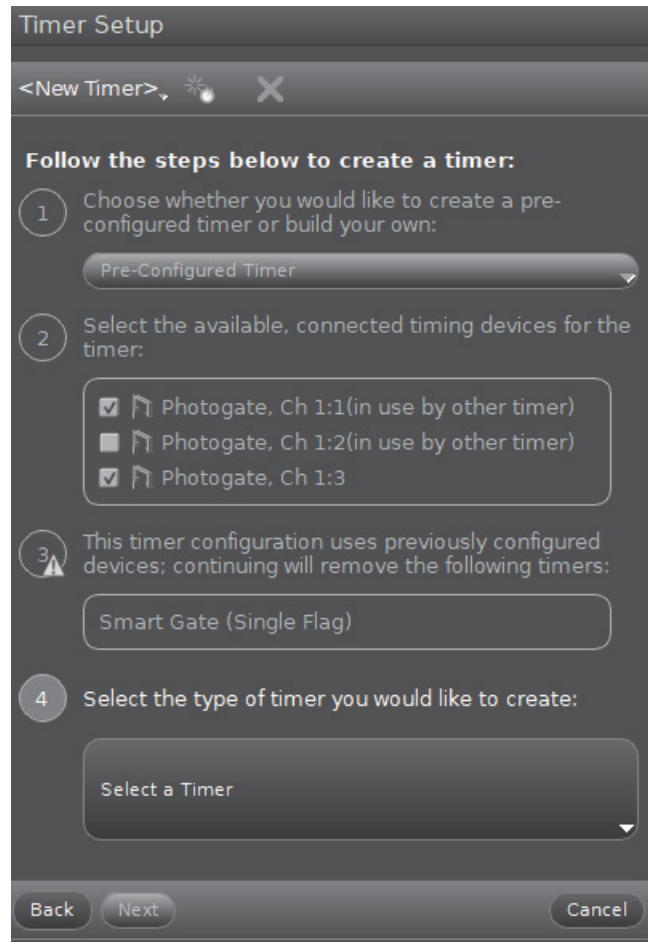

- Click the “Select a Timer” menu.

- The menu shows several timers that are designed to use two photogates

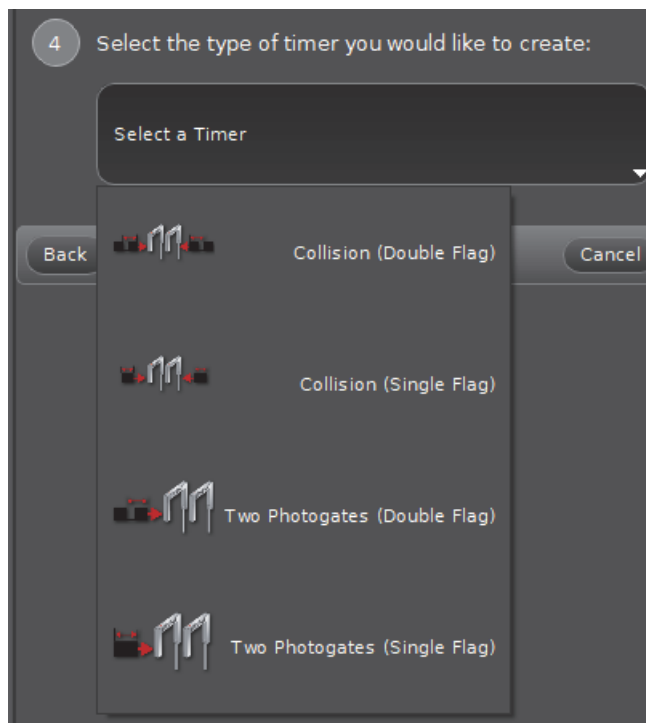

- Two of the timers are designed to work in “Conservation of Momentum” activities. The other two are designed for activities with the two photogates farther apart.

- For this example, select “Collision (Single Flag)” to open Step 5.

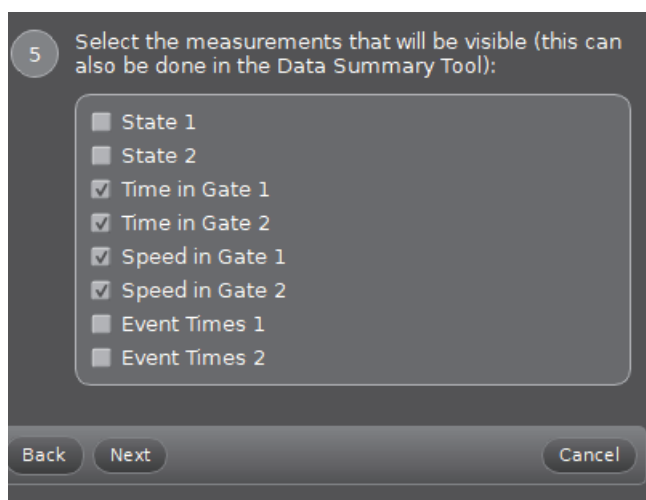

- The list shows the possible measurements with four of them selected by default.

- Click “Next” to move to Step 6.

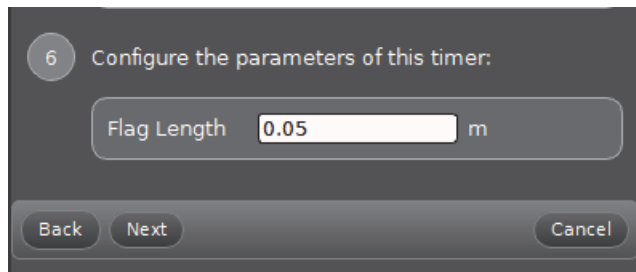

- The default Flag Length is 0.05 m (5 cm).
- Carefully measure the length of the flag you are using and, if needed, highlight the default Flag Length and enter your measured value. Click “Next” to open Step 7. You can leave the default timer’s name or enter your own name for the new timer.

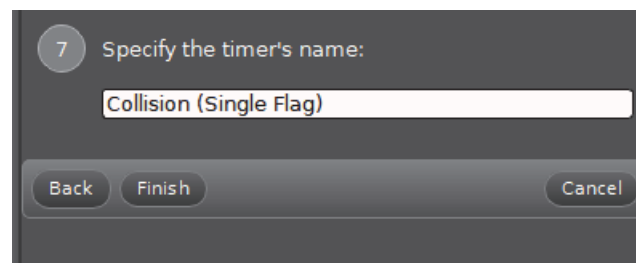

- Click “Finish”. The Timer Setup panel shows the new timer’s name. Review the panel and make changes in Step 4 or Step 5 if necessary.

## Collect Data in Capstone

- In PASCO Capstone, select a display in the main window. In the display, use the <Select Measurement> menu(s) to set up the desired measurement in the display.
- Select “Record” to begin collecting data. The Record button changes to a “Stop” button.
- Click “Stop” to end data collecting.

## Port 4, Laser Detector Port Setup

Port 4, the Laser Detector Port, is designed to work with a laser to measure the motion of objects that are too large to fit through the Wireless Smart Gate. When Port 4 is selected, the Indicator LED shines red when the laser beam is blocked or is not shining into Port 4.

The LED shines clear when the laser beam shines into Port 4. Imagine that you want to measure the period of a pendulum made with a bowling ball. You can use Port 4 and a laser. To do so, connect the Wireless Smart Gate and set up a Pendulum Timer.

1. Turn on the sensor and start the software. In PASCO Capstone, click the “Hardware Setup” icon in the Tools palette to open the Hardware Setup panel.
2. In no device is connected, the panel says “Searching for wireless devices...” and, below that, “Please connect to an interface or wireless device.”
  - The Hardware Setup panel confirms that the software is “Searching for wireless devices”. The panel shows the “Available Wireless Devices”.
3. Under “Available Wireless Devices,” click the sensor that matches the XXX-XXX Device ID number that is on one side of the Wireless Smart Gate. A “Connecting to the sensor” message appears briefly.
  - The Hardware Setup panel changes to show that the Wireless Smart Gate is connected. The panel shows the image of the Wireless Smart Gate including **Port 3**, the Auxiliary Port, and **Port 4**, the Laser Detector Port.
  - The default setup choice is “Smart Gate (Single Flag)”.
4. Click the image of Port 4.

- The image now shows a laser that appears to be shining into Port 4

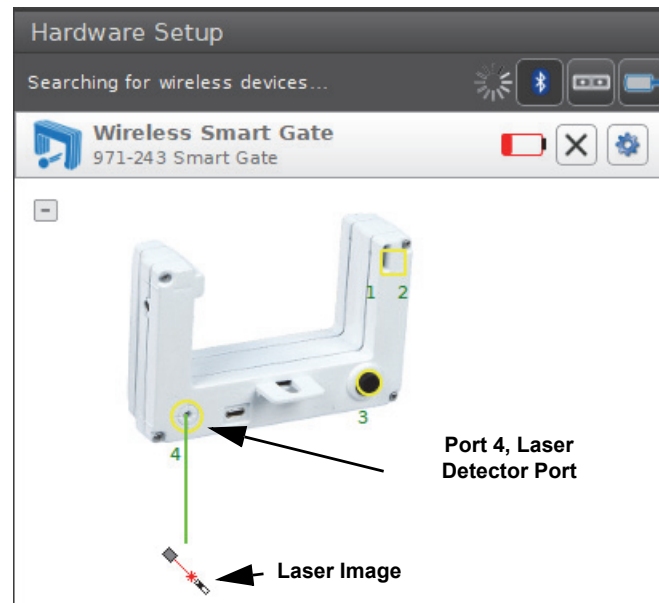

5. In the Tools palette, click the Hardware Setup icon to close the Hardware Setup panel. Click the Timer Setup icon to open the Timer Setup panel

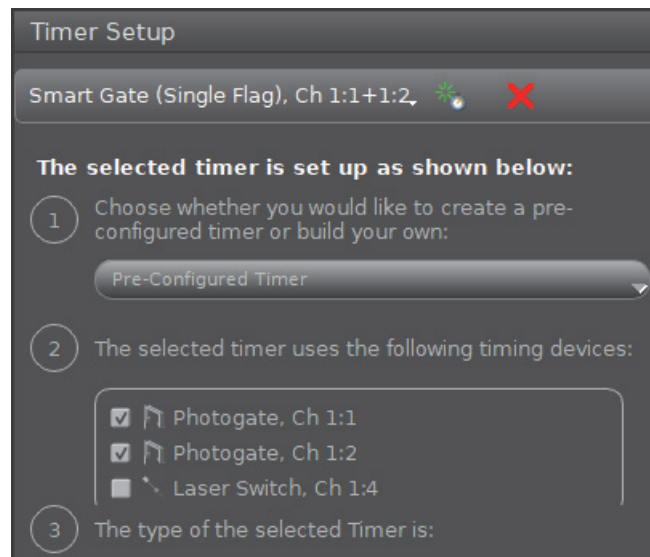

- Step 2 shows “**Laser Switch, Ch 1:4**” to indicate that Port 4 is configured. You will need to create a new pre-configured timer.
- Click the green star-shaped button.

- The new Timer Setup panel is revealed and it shows the choices in the Pre-Configured Timer menu.

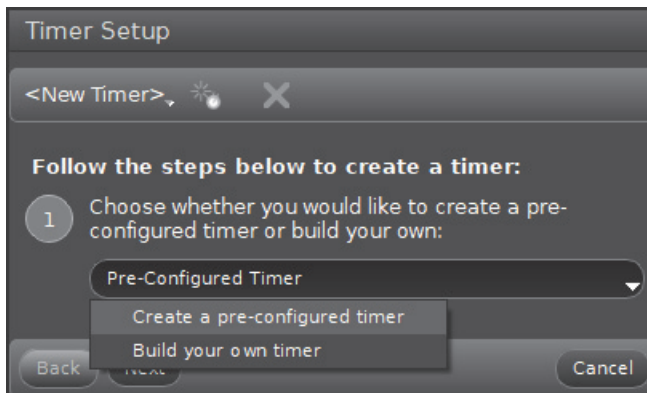

- Select "Create a pre-configured timer". Make sure that there is a checkmark in front of "Laser Switch, Ch 1:4" and then click Next.

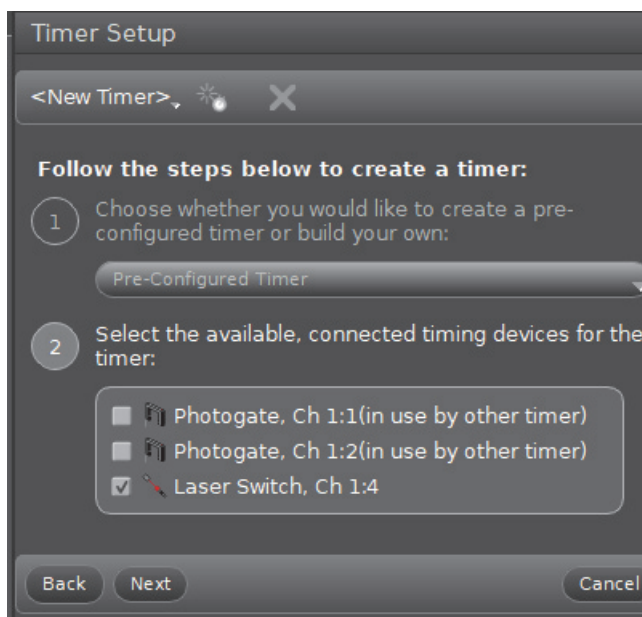

- Step 3 opens. You can select the type of timer to create.

- Click the "Select a Timer" menu button and then select "Pendulum Timer".

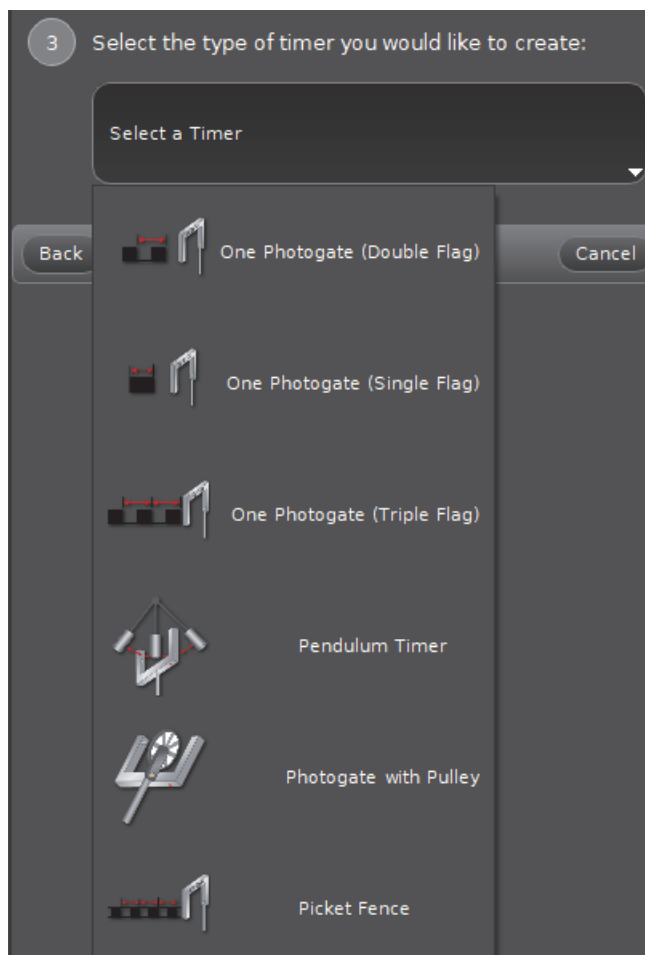

- Step 4 opens and shows the list of measurements with "Period" as the selected default.

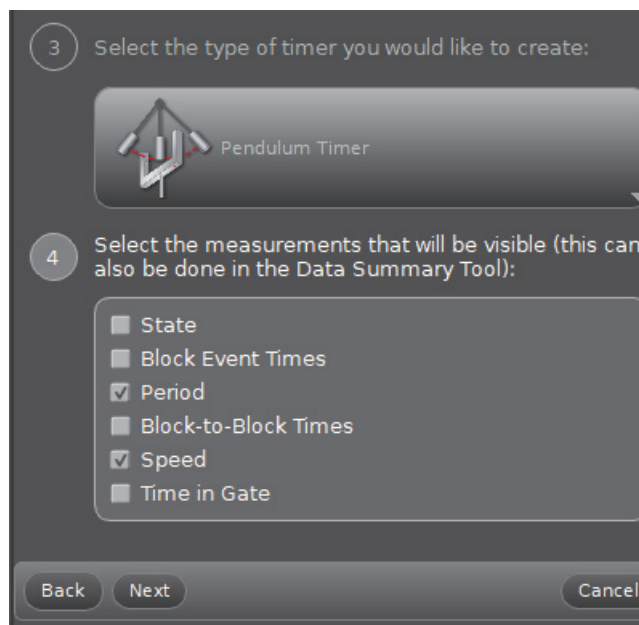

- Click “Next” to open Step 5. Carefully measure the width of your pendulum. Highlight the default width (0.016 m) and enter your measured value.

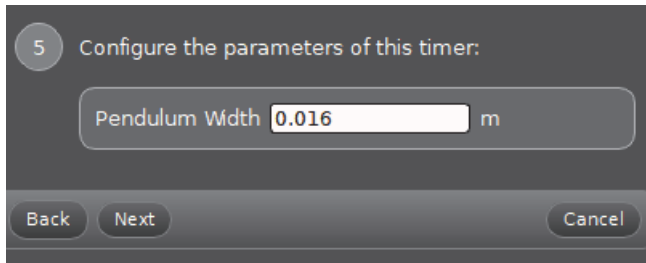

- Click “Next” to open Step 6, You can specify your own name for the timer or accept the default. Click “Finish”.

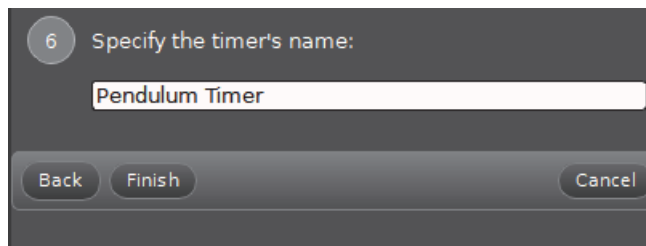

- In the Tools palette, click the Timer Setup icon to close the Timer Setup panel.

## Collect Data in Capstone

- Set up the Wireless Smart Gate and the laser so that the laser beam shines directly into Port 4. Put enough distance between the sensor and the laser that the bowling ball pendulum can swing between them.
- In PASCO Capstone, select a display in the main window. In the display, use the <Select Measurement> menu(s) to set up the desired measurement in the display.
- Let the pendulum begin to swing. Select Record to begin collecting data. The Record button changes to a “Stop” button.
- Click Stop to end data collecting.

## Troubleshooting the Sensor

- If the sensor loses Bluetooth connection and will not reconnect, try cycling the ON button. Press and briefly **hold** the button until the status LEDs blink in sequence, and then release the button. Start the sensor in the usual way.

- If the sensor stops communicating with the computer software or tablet application, try restarting the software or application. If the problem remains, press and **hold** the ON button on the sensor for 10 seconds and then release. Start the sensor in the usual way.
- On the computing device, turn Bluetooth off and then back on. Retry.
- If the Wireless Smart Gate will not turn on, use the micro USB cable to connect it to a USB port or charger.

See the PASCO web site at [www.pasco.com](http://www.pasco.com) for more information.

## Probe Care and Maintenance

- The Wireless Smart Gate is not waterproof. Do not immerse the sensor in liquid.
- If the Battery LED blinks red, the battery needs to be recharged. Connect the sensor to the Micro USB Cable and connect the USB Cable to a USB Charger or a USB Port.

## Specifications

Item	Value
Rise and Fall Time:	Symmetrical, all four ports
Infrared Source	940 nm
Minimum Block Time, Detector Ports 1 and 2	1.5 ms

## Technical Support

For assistance with any PASCO product, contact PASCO at:

Address: PASCO scientific  
10101 Foothills Blvd.  
Roseville, CA 95747-7100

Web: [www.pasco.com](http://www.pasco.com)

Phone: +1 916-462-8384 (worldwide)  
877-373-0300 (U.S.)

Email [support@pasco.com](mailto:support@pasco.com)

Check the PASCO website for the latest version of the instruction manual.

[www.pasco.com/manuals](http://www.pasco.com/manuals)

**Limited Warranty** For a description of the product warranty, see the PASCO catalog. **Copyright** The PASCO scientific *Instruction Manual* is copyrighted with all rights reserved. Permission is granted to non-profit educational institutions for reproduction of any part of this manual, providing the reproductions are used only in their laboratories and classrooms, and are not sold for profit. Reproduction under any other circumstances, without the written consent of PASCO scientific, is prohibited. Rev: 05/19. **Trademarks** PASCO, PASCO Capstone, and SPARKvue are trademarks or registered trademarks of PASCO scientific, in the United States and/or in other countries. For more information visit

[www.pasco.com/legal](http://www.pasco.com/legal).

### Product End of Life Disposal Instructions:

This electronic product is subject to disposal and recycling regulations that vary by country and region. It is your responsibility to recycle your electronic equipment per your local environmental laws and regulations to ensure that it will be recycled in a manner that protects human health and the environment. To find out where you can drop off your waste equipment for recycling, please contact your local waste recycle/disposal service, or the place where you purchased the product.

The European Union WEEE (Waste Electronic and Electrical Equipment) symbol (shown to the right and on the product or its packaging) indicates that this product **must not** be disposed of in a standard waste container.



### Battery Disposal Instructions:

Batteries contain chemicals that, if released, may affect the environment and human health. Batteries should be collected separately for recycling, and recycled at a local hazardous material disposal location adhering to your country and local government regulations. To find out where you can drop off your waste battery for recycling, please contact your local waste disposal service, or the product representative.

The Lithium Polymer (Li-Poly) rechargeable battery used in this product is marked with the International symbols to indicate the need for the separate collection and recycling of batteries.



Li-Poly



## Appendix A: Bluetooth Compatibility

Check the PASCO website at [www.pasco.com/compatibility](http://www.pasco.com/compatibility).

Platform	Bluetooth SMART Compatibility
iOS	iPad 3 and later iPhone 4S and later iPod touch 5 and later
SPARK LX / LXi	All models
Android	Android 4.4 and later
Chrome OS	Chromebooks with Bluetooth 4.0
Mac OS X	Models introduced July 2011 or later <sup>1</sup>
Windows	Windows 7 and later (requires PS-3500 Adapter*)
Windows 10 Creator	All models

\*The PS-3500 USB Bluetooth 4.0 Adapter, when connected to a USB port, allows up to three Bluetooth SMART devices, such as this PASCO wireless device, to connect to some Windows computers, some Chromebooks, and older Macintosh computers.

Note: The PS-3500 USB Bluetooth 4.0 Adapter is the only adapter we can currently recommend. Many other Bluetooth 4.0 adapters are available but this adapter has a specific design that enables in-app pairing of Bluetooth SMART sensors.



<sup>1</sup>To check the Mac computer's Bluetooth compatibility, do the following:

- Click the  (Apple) Menu.
- Select *About This Mac*
- Click the *System Report...* button.
- Select *Bluetooth* from the sidebar on the left, underneath *Hardware*.
- Scan down the list of information until you find "LMP Version".
- If your Mac is equipped with Bluetooth SMART, the LMP Version will show **0x6**. (Anything lower than **0x6** means an older version of Bluetooth. Your device will need the PS-3500 USB Bluetooth 4.0 Adapter.)

<sup>1</sup>The Mac Mini and MacBook Air were updated with Bluetooth SMART support in 2011. The MacBook Pro was updated in 2012. The Mac Pro that debuted in December 2013 has Bluetooth SMART support.

**Exception:** Before you upgrade to El Capitan (Mac OS X 10.11.x), if you have a Macintosh with LMP version "0x4" that requires the PS-3500 USB Bluetooth 4.0 Adapter, please contact PASCO Technical Support for further instructions.



## Appendix B: UK Timing Modes in SPARKvue

In addition to the previously described Smart Gate Timing Modes, SPARKvue also supports the UK Timing Modes. To access the UK Timing Modes, click or touch the menu icon in the upper left corner of the home screen.

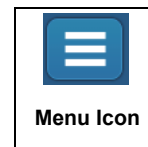

In the SPARKvue menu that opens, select “Choose Language...”. English is the default language choice. **Note:** UK Timing Modes are only available in English. Click or touch “On” to Enable UK Timing Modes. Click or touch “OK”. The “Select Language” window closes and the **Assign SmartGate** UK Timing Modes window opens.

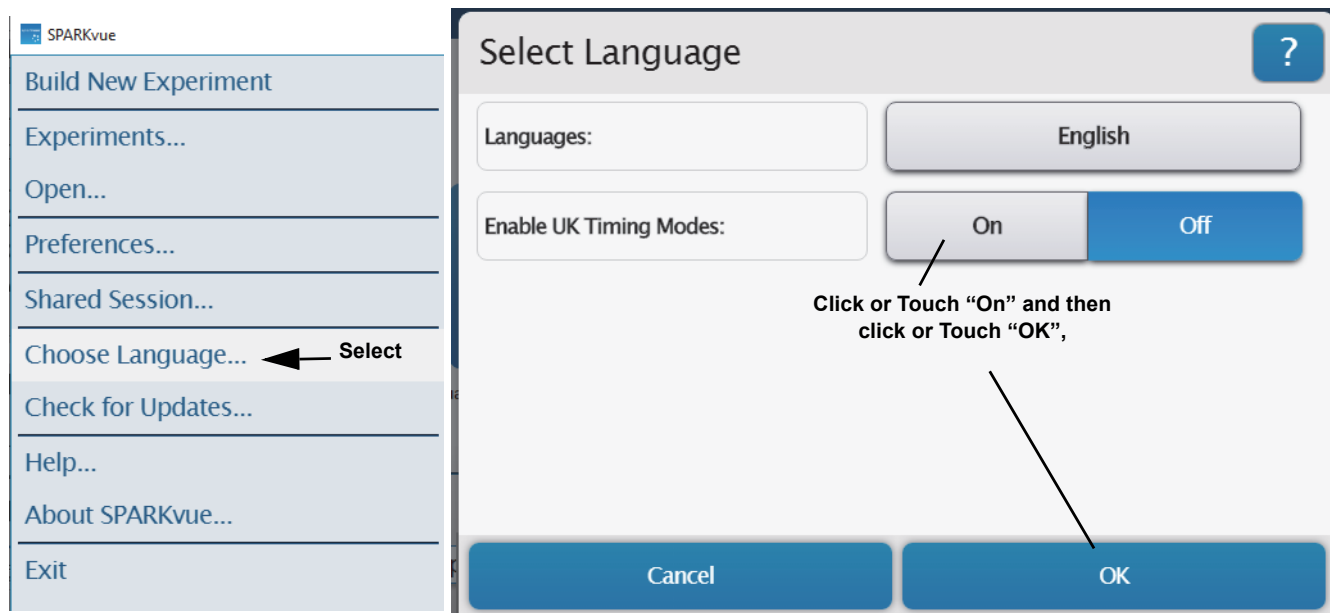

SPARKvue Menu-  
Select “Choose  
Language...”

By default, the **Assign SmartGate** window shows the four UK Timing Modes menu choices:

- One Light Gate and Single Interrupt Card
- Two Light Gates and Single Interrupt Card
- One Light Gate and Double Interrupt Card
- Two Light Gates and Double Interrupt Card.

In addition, the **Assign SmartGate** window shows the Smart Gate Only, Smart Gate and Auxiliary Port, and Auxiliary Port Only menu titles.

### 1. UK Timing Modes - One Light Gate and Single Interrupt Card

- Click or touch “One Light Gate and Single Interrupt Card” to select that menu choice. Click or touch “OK” to activate that menu choice and close the panel.

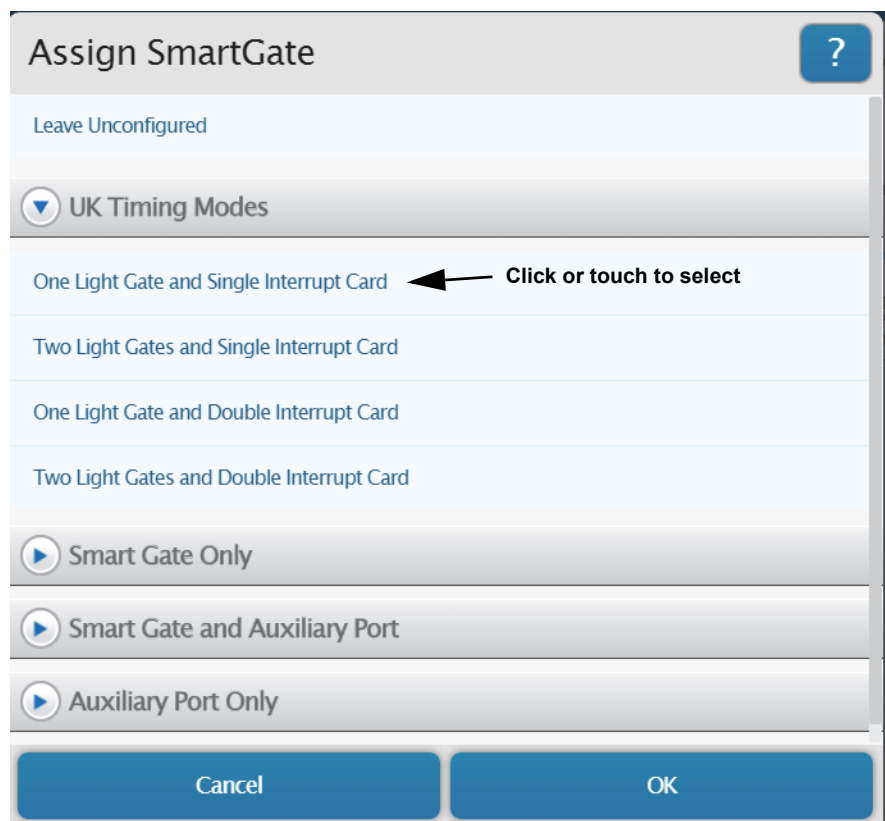

- The “Edit Timer Properties:” window is revealed. The default choices are “Time” and “Speed/Velocity”. By default, “acceleration” is disabled for this timing mode. The default “Length of Card” is 0.025 m.
- Carefully measure the length of the card you are using. If the Length of Card needs to be changed, highlight the default value and enter your value.
- Click or touch “Done” to accept your value and close the panel.
- The “Select Measurements for Templates” window appears. The measurement choices are “Speed at A” and “Time in Gate A” with “Speed at A” as the default choice.

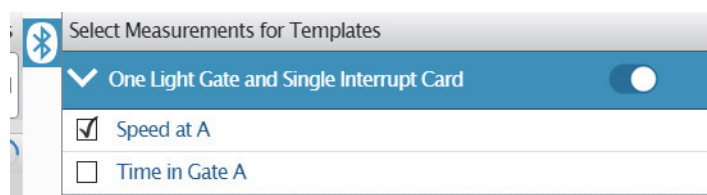
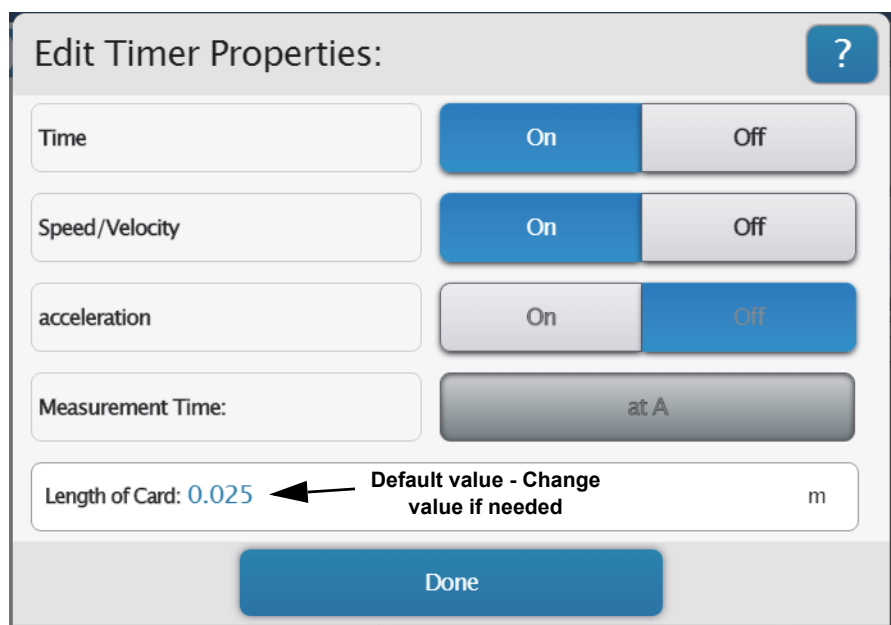

### Record and Display Data In SPARKvue

1. Select a Display Template such as “Graph”, “Digits” or “Table and Graph” from the Templates panel.

- The selected Display Template appears with “Speed at A” as the default measurement choice.

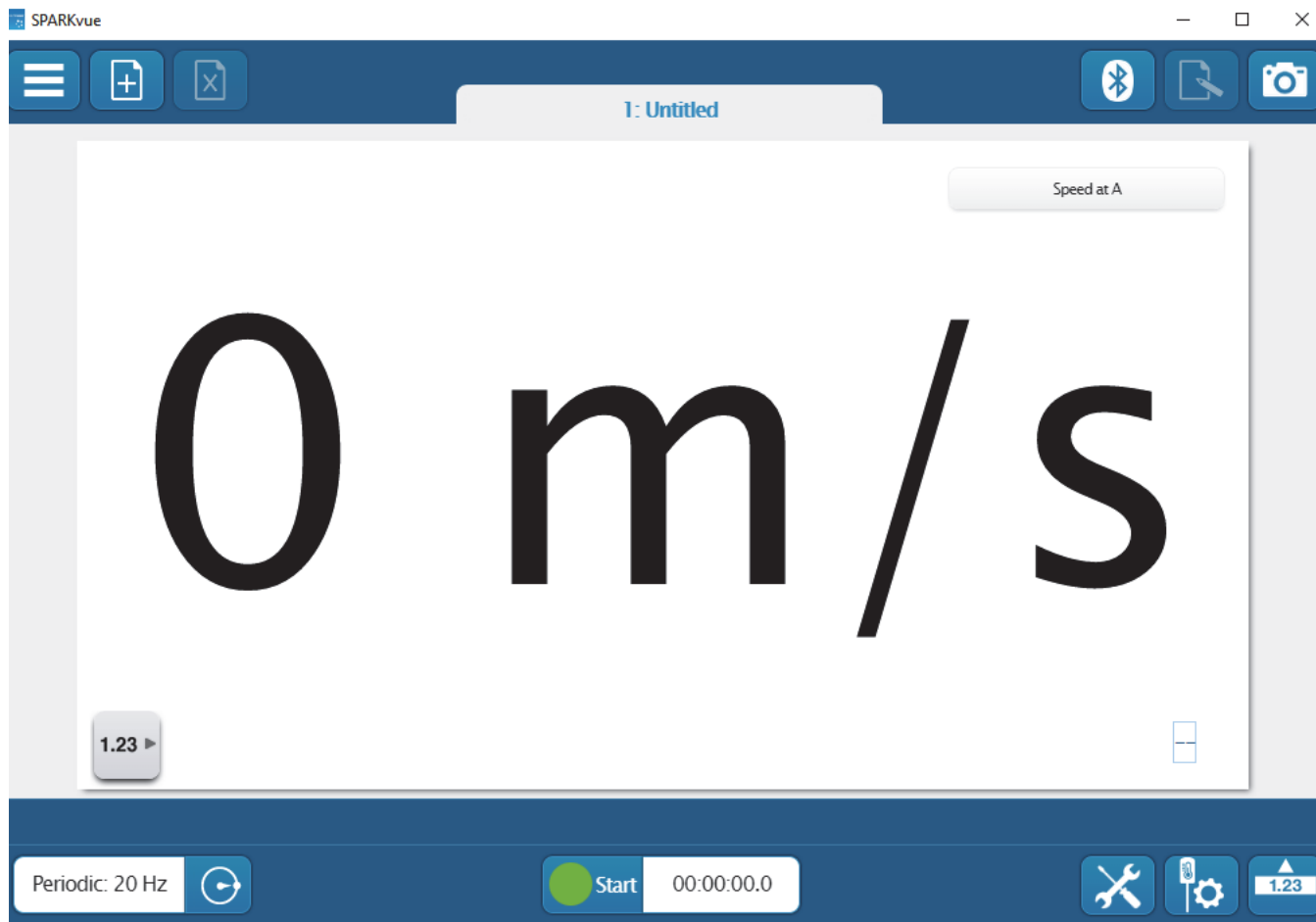

2. Click or Touch the green “Start” button to start collecting data. Watch the display as you pass a finger back and forth through the Wireless Smart Gate.
  - The Display shows the values of the Speed at A. The “Start” button changes to a red “Stop” button.
3. Click or Touch the red “Stop” button to stop collecting data.

## Appendix C: UK Timing Modes in PASCO Capstone

- In addition to the previously described Smart Gate Timing Modes, PASCO Capstone also supports the UK Timing Modes available in English only. To access the UK Timing Modes, click or touch the File menu. Select “Preferences” from the menu.

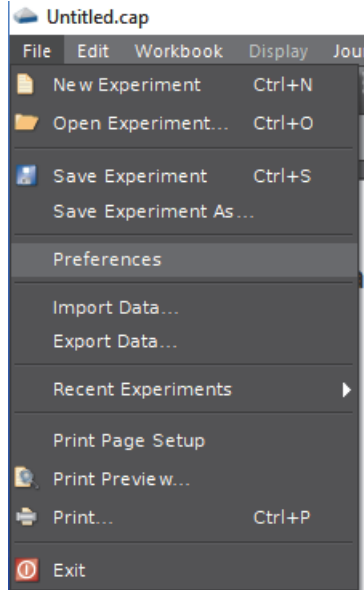

- In the Properties panel that opens, select “Language”. English is the default language choice. Below the Language menu is “Enable UK Timing Modes”. Add a checkmark to the box. Click “OK” to close the window and return to the main workbook menu.

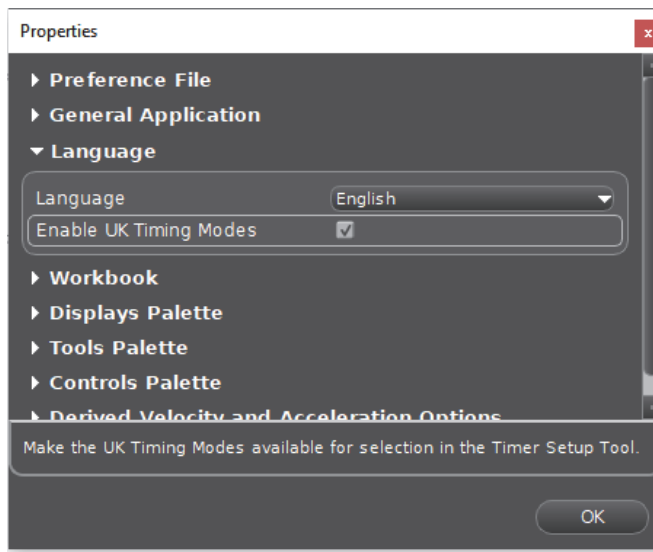

## Connect the Sensor Wirelessly in PASCO Capstone

- Turn on the sensor and start the software. In the PASCO Capstone Tools palette, click the “Hard-

ware Setup” icon to open the Hardware Setup panel.

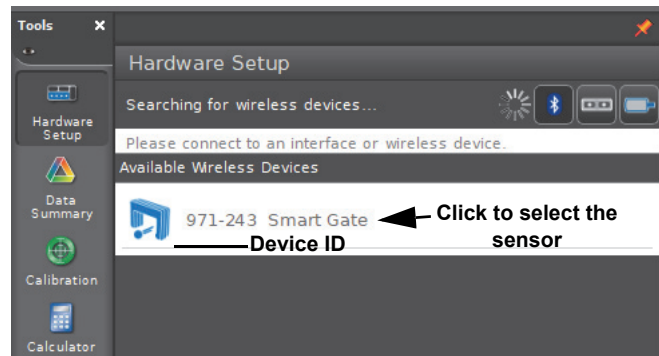

- If no device is connected, the panel says “Searching for wireless devices...”. and, below that, “Please connect to an interface or wireless device.” The panel shows the “Available Wireless Devices”.
- Under “Available Wireless Devices,” click the sensor that matches the XXX-XXX Device ID number that is on one side of the Wireless Smart Gate.
- A “Connecting to the sensor” message appears briefly.
  - The Hardware Setup panel changes to show the image of the Wireless Smart Gate including Port 3, the Auxiliary Port. and Port 4, the Laser Detector Port.

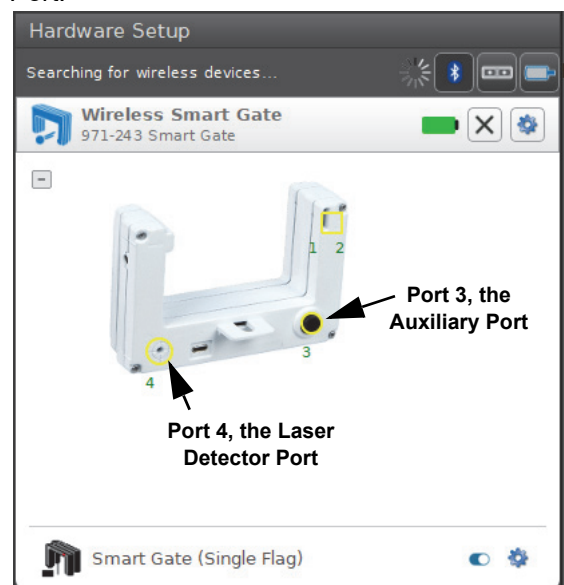

- The default setup choice is “Smart Gate (Single Flag)”.

### Smart Gate (Single Flag) Setup

1. Click the “Hardware Setup” icon in the Tools palette to close the “Hardware Setup” panel.

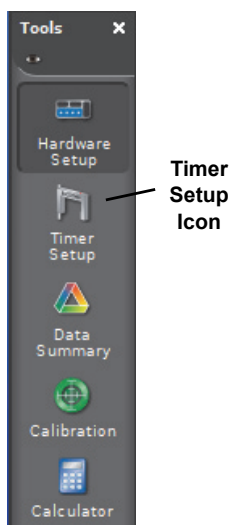

2. Click the “Timer Setup” icon in the tools palette to open the Timer Setup panel.

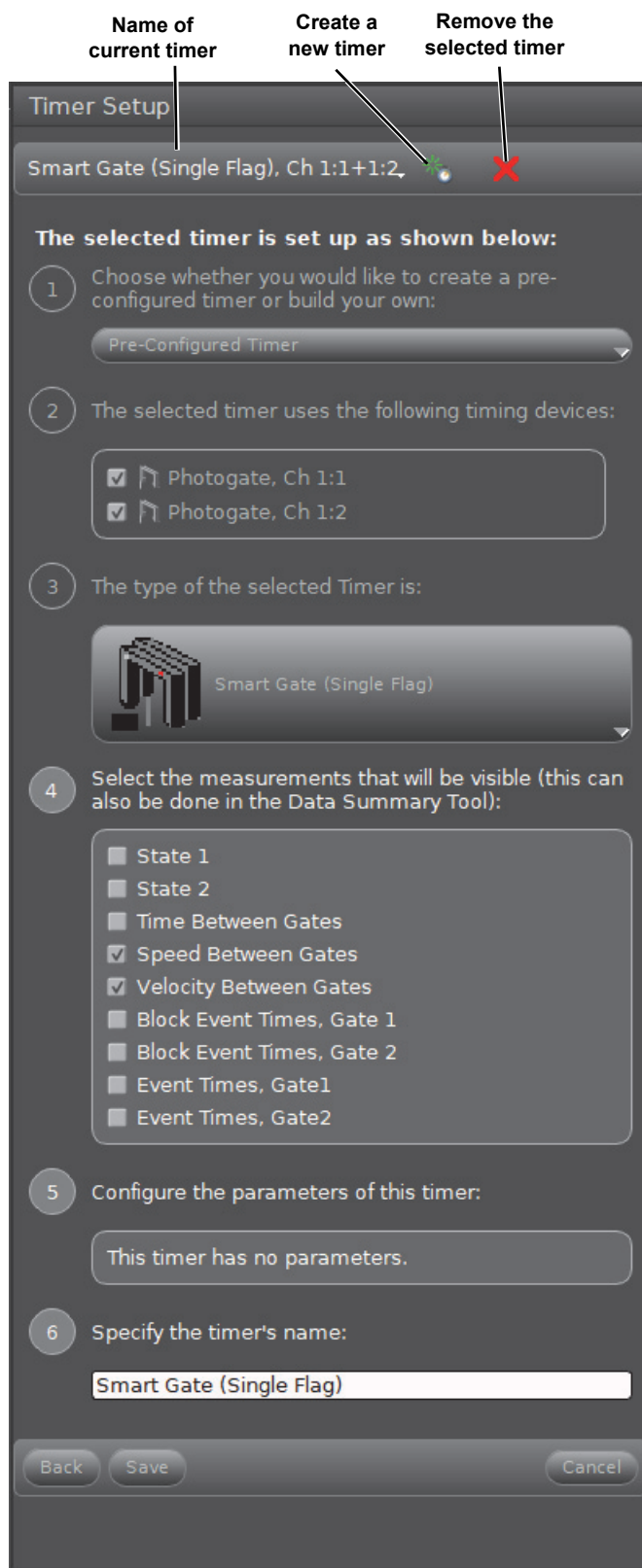

- The Timer Setup panel is revealed. The Timer Setup panel is the same as it was previously for

setting up a Timer in PASCO Capstone. You can go through the same process to create a Timer Setup for UK Timing Modes.

- Click the green star-shaped button to create a new Timer Setup.
- Select "Pre-Configured Timer". Select "Next".

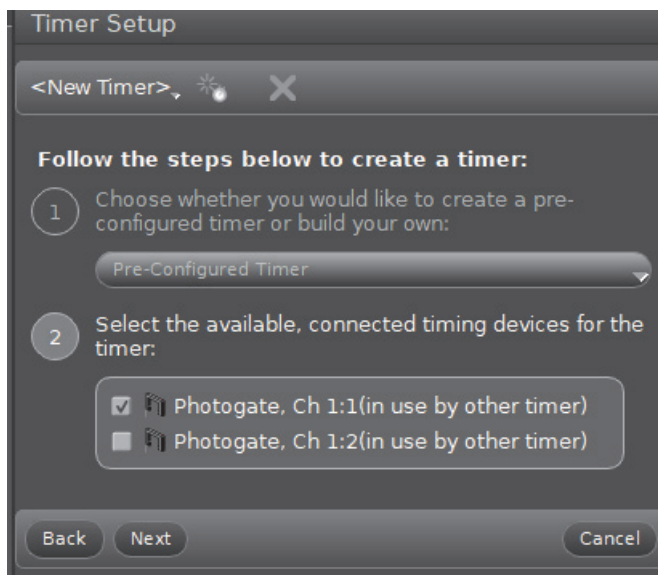

- Click "Next" to open Step 3

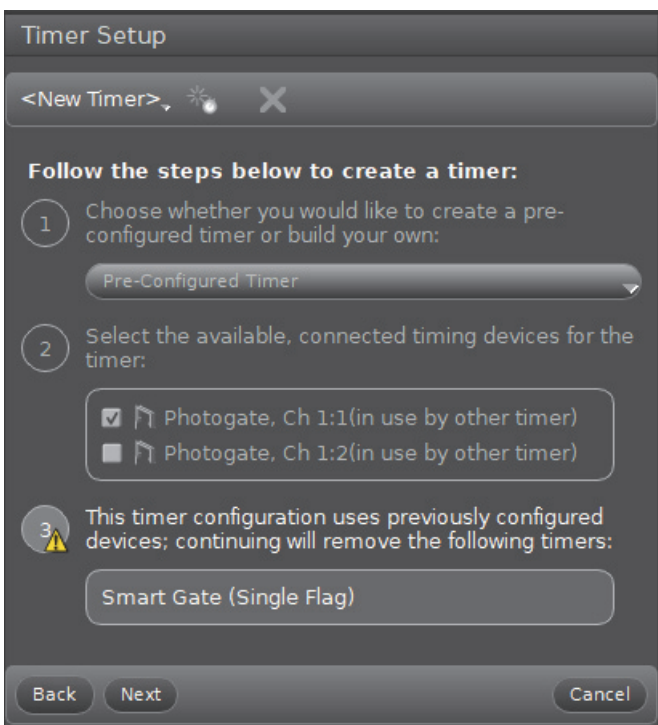

- Step 3 warns that the default timer (Smart Gate (Single Flag)) will be removed. Ignore the warning.

- Click "Next" to open Step 4.

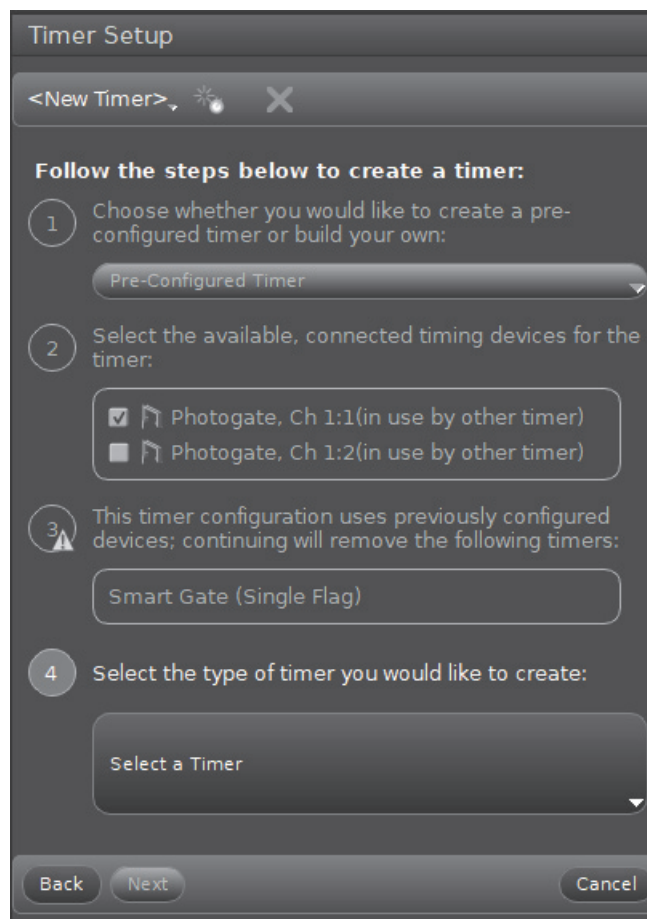

- Step 4 allows you to select the type of timer you would like to create.

7. Click the Select a Timer menu button.

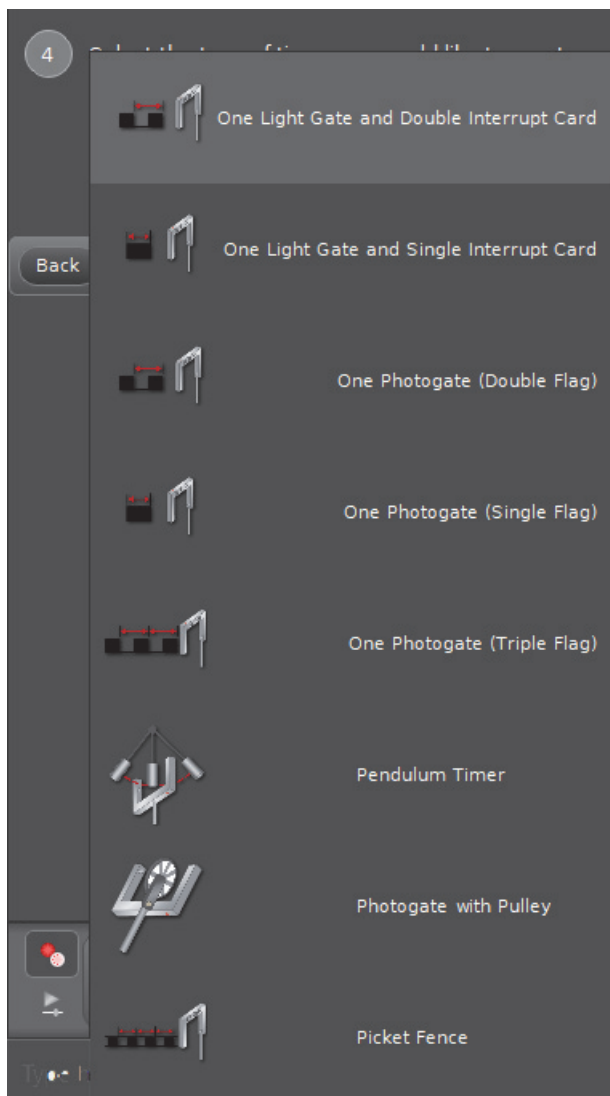

- This shows a long list of Timer choices.

8. For this example, select “One Light Gate and Single Interrupt Card”.

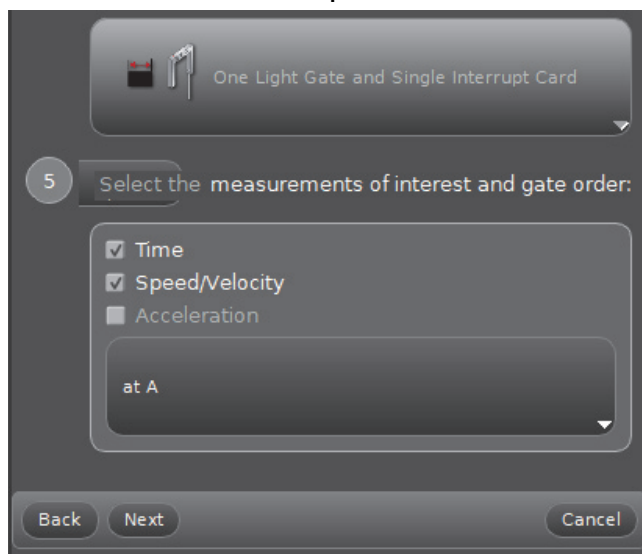

- The default measurements are “Time” and “Speed/Velocity”. The “gate order” is at A. For this example, the “Acceleration” default choice is not acceptable because One Light Gate can’t determine acceleration. The other choices are acceptable.

9. Click “Next” to open Step 6.

- Note that “Speed/Velocity” is now “Speed at A” because there is not enough information to determine direction.

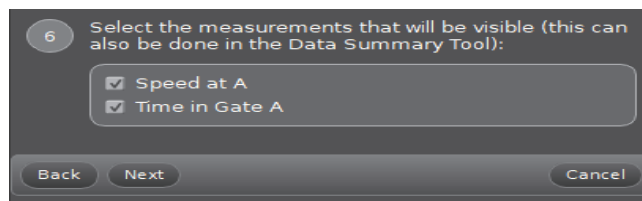

10. Because these measurements are acceptable, click “Next” to open Step 7.

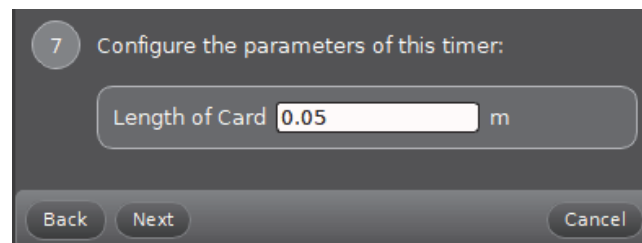

- Step 7 shows that the Length of Card is 0.05 m (5 cm).

11. Carefully measure the length of the card you are using to interrupt the Light Gate. If needed, highlight the default value and enter your measured length.
12. Click “Next” TO open Step 8.

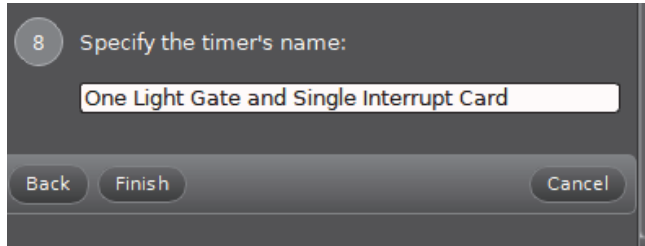

- You can use Step 8 to enter a specific name for the timer.
13. Click “Finish”.
  - You can review the details of the Timer Setup and make changes if needed.
  14. Setup to Record and Display data using PASCO Capstone as described previously.



*15. Appendix D: Build a Custom Timer in PASCO  
Capstone is UNDER CONSTRUCTION.*

See [www.pasco.com](http://www.pasco.com) for the latest version of this manual.

